



Cierre Embutido **BRK8033**

# LÍNEA EUROPEA CATÁLOGO

**Brüken**  
ASSA ABLOY

TABLA DE USOS EN PERFILES

PRODUCTO	CLAVE	SKU	FAMILIA	INDALUM			SERIES ABATIBLES						SERIES CORREDIZAS				
				P2500	V4000	V4500	CUPRUM				EXT. MET.		CUPRUM		EXT. MET.		
							AB V	AB P	V50	P50	1400 V	1400 P	70	80	4600	10000	
	BRK8040	MX66994	Escuadra			✓											Riel
	BRK8041	MX66995	Escuadra		✓	✓	Marco/ hoja	Marco/ hoja				Opción	Opción		Marco	Opción riel triple	Hoja
	BRK8042	MX66996	Escuadra		✓										Hoja	Opción	
	BRK8043	MX66997	Escuadra				✓										Riel bajo
	BRK8045	MX67040	Escuadra	✓							✓						
	BRK8046	MX67041	Escuadra	✓								✓					
	BRK8050	MX67042	Escuadra	✓			✓				✓						
	BRK8051	MX67043	Escuadra	✓				✓				✓					
	BRK8055	MX67044	Escuadra		✓											3 Rieles	
	BRK8056	MX67045	Escuadra		✓											Hoja	
	BRK8057	MX67046	Escuadra		✓											Riel	
	BRK8071	MX67051	Goma								✓	✓					
	BRK8072	MX67052	Goma								✓	✓					
	BRK8065	MX67049	Empaque				✓	✓									
	BRK8066	MX67050	Empaque				✓	✓									
	FF200G FF200N	MX65228 MX65227	Felpa		✓								✓			✓	
	BRK8076	MX66998	Felpa			✓									✓		✓
	BRK8002	MX66999 MX67000 MX67001	Bisagra	✓			✓				✓						
	BRK8003	MX67002 MX67003 MX67004	Bisagra	✓								✓					
	BI70	MX65391 MX65392 MX65393	Bisagra						✓	✓							
	PF3	MX65131	Carretilla											✓			
	BRK8021A	MX67005	Carretilla											✓			
	TANDEM	MX65154	Carretilla											✓			
	PLIN70	MX65145	Carretilla											✓			
	BRK8023A	MX67007	Carretilla											✓			
	DOPLIN70	MX65153	Carretilla											✓			
	BRK8022A	MX67008	Carretilla											✓			

Los productos presentados en este catálogo, pueden ser modificados, derivados de nuestros procesos de innovación y mejora continua.

Todos nuestros productos cuentan con garantía. Las presentaciones de venta de nuestros productos (caja, blíster, master, corrugado, etc.) pueden cambiar sin previo aviso.

Acotaciones en milímetros, se recomienda solicitar ficha técnica y verificar físicamente previo a instalación y perforación.

PRODUCTO	CLAVE	SKU	FAMILIA	INDALUM			SERIES ABATIBLES						SERIES CORREDIZAS				
				P2500	V4000	V4500	CUPRUM				EXT. MET.		CUPRUM		EXT. MET.		
							AB V	AB P	V50	P50	1400 V	1400 P	70	80	4600	10000	
	BRK8024B	MX67009	Carretilla											✓			
	BRK8024A	MX67010	Carretilla											✓			
	BRK8025A	MX67011	Carretilla											✓			
	BRK8026B	MX67012	Carretilla													✓	
	BRK8026A	MX67013	Carretilla													✓	
	BRK8027A	MX67014	Carretilla													✓	
	BRK8028A	MX67015	Carretilla			✓											✓
	BRK8029A	MX67016	Carretilla			✓											✓
	BRK8030L BRK8030R	MX67017 MX67018 MX67019 MX67020 MX67021 MX67022	Cierre	✓			✓		✓		✓						
	BRK8060	MX67121 MX67124 MX67126 MX67241 MX67828 MX67243 MX67244 MX67245 MX67246	Cierre	✓				✓			✓	✓	(No monumental)				
	BRK8080	MX67024	Cierre	✓				✓		✓		✓	(No monumental)				
	BRK8031	MX67023	Cierre	✓				✓				✓					
	BRK8033	MX67025 MX67026 MX67027	Cierre		✓	✓								✓	✓	✓	✓
	BRK8034	MX67028 MX67029 MX67030	Cierre		✓	✓								✓	✓	✓	✓
	BRK8035	MX67031	Cierre											✓			
	BRK8036	MX67032	Cierre		✓										✓	✓	
	BRK8037	MX67033	Cierre			✓											✓



## BISAGRAS

BRK 8002			
SKU	Acabado	Características	
MX66999	Blanco	Bisagra de dos palas, para ventanas de la línea española. Serie: P2500, AB V y 1400 V	
MX67000	Negro		
MX67001	Natural		

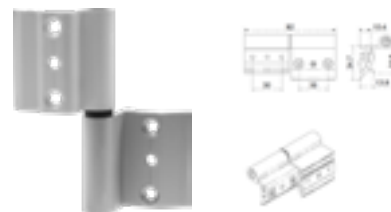

BRK 8003			
SKU	Acabado	Características	
MX67002	Blanco	Bisagra de tres palas, para puertas de la línea española. Serie: P2500 y 1400 P	
MX67003	Negro		
MX67004	Natural		

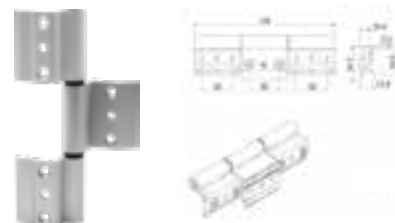

TecnoMX<sup>®</sup>  
ASSA ABLOY

BI70			
SKU	Clave comercial	Acabado	Características
MX65391	BI70BL	Blanco	Bisagra para puerta y ventana abatible, línea Eurovent. Serie: V50 y P50
MX65393	BI70D4	Negro	
MX65392	BI70NA	Natural	

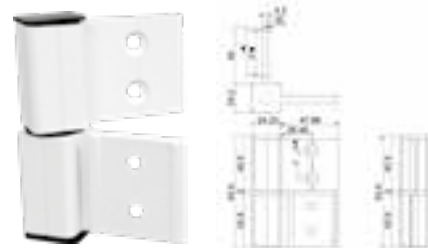

## CARRETILLAS

TecnoMX<sup>®</sup>  
ASSA ABLOY

PF3	
SKU	Características
MX65131	Carretilla fija de unza rodaja de nylon con baleros. Capacidad de carga: 25 kg Serie: 70



BRK 8021 A	
SKU	Características
MX67005	Carretilla fija de una rodaja de nylon con agujas. Capacidad de carga: 70 kg Serie: 70



TecnoMX<sup>®</sup>  
ASSA ABLOY

TANDEM	
SKU	Características
MX65154	Carretilla fija de dos rodajas de nylon con baleros. Capacidad de carga: 50 kg Serie: 70



TecnoMX+

ASSA ABLOY

PLIN70	
SKU	Características
MX65145	Carretilla ajustable de una rodaja de nylon con baleros. Capacidad de carga: 25 kg Serie: 70



TecnoMX+

ASSA ABLOY

DOPLIN70	
SKU	Características
MX65153	Carretilla ajustable de dos rodaja de nylon con baleros. Capacidad de carga: 50 kg Serie: 70

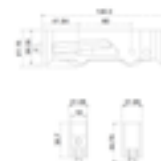

BRK 8023 A	
SKU	Características
MX67007	Carretilla ajustable de una rodaja de nylon con agujas. Capacidad de carga: 70 kg Serie: 70



BRK 8022 A	
SKU	Características
MX67008	Carretilla ajustable de dos rodaja de nylon con agujas. Capacidad de carga: 140 kg Serie: 70



BRK 8024 A	
SKU	Características
MX67010	Carretilla ajustable de una rodaja de nylon con agujas. Capacidad de carga: 50 kg Serie: 80



BRK 8024 B	
SKU	Características
MX67009	Carretilla mosquitero ajustable de una rodaja de nylon con baleros. Capacidad de carga: 15 kg Serie: 80



BRK 8025 A	
SKU	Características
MX67011	Carretilla ajustable de dos rodajas de nylon con agujas. Capacidad de carga: 100 kg Serie: 80



BRK 8026 B	
SKU	Características
MX67012	Carretilla mosquitero ajustable de una rodaja de nylon con baleros. Capacidad de carga: 15 kg Serie: 4600



BRK 8026 A	
SKU	Características
MX67013	Carretilla ajustable de una rodaja de nylon con agujas. Capacidad de carga: 40 kg Serie: 4600



BRK 8027 A	
SKU	Características
MX67014	Carretilla ajustable de dos rodajas de nylon con agujas. Capacidad de carga: 100 kg Serie: 4600

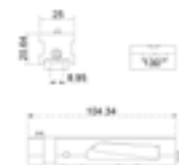

BRK 8028 A	
SKU	Características
MX67015	Carretilla ajustable de una rodaja de nylon con agujas. Capacidad de carga: 70 kg Serie: V4500 y 10000



BRK 8029 A	
SKU	Características
MX67016	Carretilla ajustable de dos rodajas de nylon con agujas. Capacidad de carga: 140 kg Serie: V4500 y 10000



P0001	
SKU	Características
MX66941	Carretilla para PVC. Capacidad de carga: 100 kg



**¡NUEVO!**

CIERRE



KIT BRK 8060 | BRK 8061 | BRK 8063 | BRK 8064

SKU	Clave comercial	Manija	Cilindro	Acabado	Características
MX67121	BRK8060 BL	Ovalada	Descentrado	Blanco	<b>Contenido:</b> • Manija • Chapetón • Cilindro • Mecanismo • Placas de ajuste
MX67124	BRK8061 BL	Cuadrada		Blanco	
MX67126	BRK8061 NA			Natural	
MX67241	BRK8063 BL	Ovalada	Centrado	Blanco	
MX67828	BRK8063 NG			Negro	
MX67243	BRK8063 NA			Natural	
MX67244	BRK8064 BL	Cuadrada	Blanco		
MX67245	BRK8064 NG		Negro		
MX67246	BRK8064 NA		Natural		

BRK 8030

SKU	Clave comercial	Características
MX67017	BRK 8030LBlanco	<b>Cierre a presión, para ventana izquierdo y derecho.</b> <b>Material:</b> Zamak <b>Acabado:</b> Blanco, negro y natural <b>Serie:</b> P2500, AB V, V50 y 1400 V
MX67018	BRK 8030LNegro	
MX67019	BRK 8030LNatural	
MX67020	BRK 8030RBlanco	
MX67021	BRK 8030RNegro	
MX67022	BRK 8030RNatural	

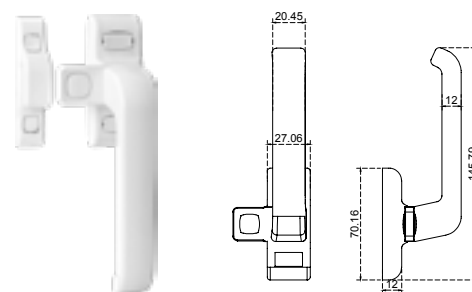

BRK 8031

SKU	Características
MX67023	<b>Doble Cilindro Alta Seguridad.</b> <b>Medidas:</b> 30x40 mm <b>Material:</b> Acero Inoxidable <b>Acabado:</b> Satin <b>Serie:</b> P2500, AB P y 1400 P

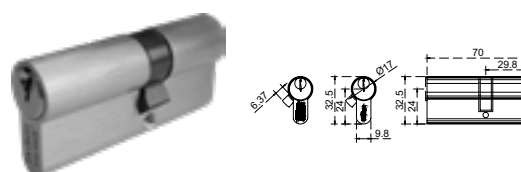

BRK 8080

SKU	Características
MX67024	<b>Cerradura paleta de embutir para perfiles de aluminio.</b> <b>Backset de 20 mm x 85 mm</b> <b>Material vista:</b> Acero inoxidable en frentes de cerraduras y cerraderos <b>Fijación:</b> A zocolo <b>Acabado:</b> Satin <b>Serie:</b> P2500, AB P, P50 Y 1400 P (no monumental)

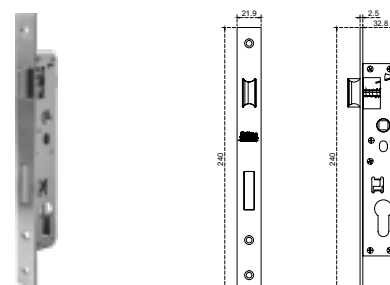



BRK 8033		
SKU	Clave comercial	Características
MX67025	BRK8033 Blanco	<b>Cierre embutido, con cerrojo, sin tornillo.</b> <b>Material:</b> Aluminio <b>Acabado:</b> Blanco, negro y natural <b>Fijación:</b> A zoclo <b>Serie:</b> V4000, V4500, 70, 80, 4600 y 10000
MX67026	BRK8033 Negro	
MX67027	BRK8033 Natural	



BRK 8034		
SKU	Clave comercial	Características
MX67028	BRK8034 Blanco	<b>Cierre embutido sin gancho y contra. Con tornillo al frente.</b> <b>Material:</b> Aluminio <b>Acabado:</b> Blanco, negro y plata <b>Fijación:</b> A zoclo <b>Serie:</b> V4000, V4500, 70, 80, 4600 y 10000
MX67029	BRK8034 Negro	
MX67030	BRK8034 Natural	



BRK 8035	
SKU	Características
MX67031	<b>Set contra y gancho para jaladeras de embutir.</b> <b>Material:</b> Aluminio <b>Acabado:</b> Natural <b>Fijación:</b> A zoclo <b>Serie:</b> 70

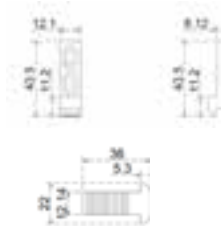

BRK 8036	
SKU	Características
MX67032	<b>Set contra y gancho para jaladeras de embutir.</b> <b>Material:</b> Aluminio <b>Acabado:</b> Natural <b>Fijación:</b> A zoclo <b>Serie:</b> V4000, 70 y 80

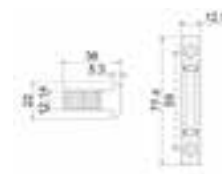

BRK 8037	
SKU	Características
MX67033	<b>Set contra y gancho para jaladeras de embutir.</b> <b>Material:</b> Aluminio <b>Acabado:</b> Natural <b>Fijación:</b> A zoclo <b>Serie:</b> V4500 y 10000

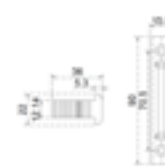

## ESCUADRAS

BRK 8040	
SKU	Características
MX66994	<b>Escuadra de botón para hoja y marco.</b> <b>Medidas:</b> 23.7 x 14.6 mm <b>Acabado:</b> Natural <b>Serie:</b> V4500 y 10000 (riel)

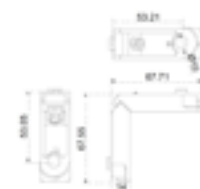

Los productos presentados en este catálogo, pueden ser modificados, derivados de nuestros procesos de innovación y mejora continua.

Todos nuestros productos cuentan con garantía. Las presentaciones de venta de nuestros productos (caja, blister, master, corrugado, etc.) pueden cambiar sin previo aviso. Acotaciones en milímetros, se recomienda solicitar ficha técnica y verificar físicamente previo a instalación y perforación.



BRK 8041	
SKU	Características
MX66995	<p>Escuadra de botón para hoja y marco.                      Medidas: 35.9 x 13.9 mm                      Acabado: Natural                      Serie: V4000, V4500, AB V (marco/hoja), AB P (marco/hoja), 1400 V, 1400 P, 80 (marco), 4600 (opción riel triple), 10000 (hoja), S45 (Fijo, ventana y puerta), S150 (Fijo, marco y hoja)</p>

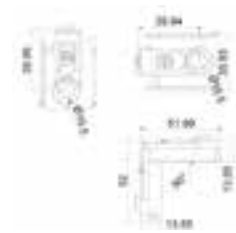

BRK 8042	
SKU	Características
MX66996	<p>Escuadra de botón para hoja y marco.                      Medidas: 22.4 x 10.4 mm                      Acabado: Natural                      Serie: V4000, 80 (hoja) y 4600</p>



BRK 8043	
SKU	Características
MX66997	<p>Escuadra de botón para para hoja y marco.                      Medidas: 11.6 x 10.1mm                      Acabado: Natural                      Serie: AB V y 10000 (riel bajo)</p>



BRK 8045	
SKU	Características
MX67040	<p>Escuadra unión para ventana.                      Serie: P2500 y 1400 V                      Acabado: Natural</p>

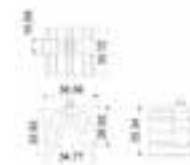

BRK 8046	
SKU	Características
MX67041	<p>Escuadra unión para puerta.                      Serie: P2500 y 1400 P                      Acabado: Natural</p>



BRK 8050	
SKU	Características
MX67042	<p>Unión pilastra para ventana.                      Serie: P2500, AB V, y 1400 V                      Acabado: Natural</p>



BRK 8051	
SKU	Características
MX67043	<p>Unión pilastra para puerta.                      Serie: P2500, AB P y 1400 P                      Acabado: Natural</p>



BRK 8055	
SKU	Características
MX67044	<p>Escuadra tetón, de extrusión de aluminio con pivote y tornillo llave allen.                      Serie: V4000 y 4600 (3 rieles)                      Acabado: Natural</p>

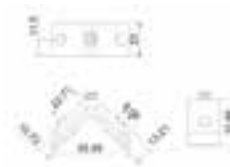

BRK 8056	
SKU	Características
MX67045	<p>Escuadra tetón, de extrusión de aluminio con pivote y tornillo llave allen.                      Serie: V4000 y 4600 (hoja)                      Acabado: Natural</p>

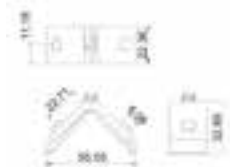

BRK 8057	
SKU	Características
MX67046	<p>Escuadra tetón, de extrusión de aluminio con pivote y tornillo llave allen.                      Serie: V4000 y 4600 (riel)                      Acabado: Natural</p>



## GOMAS, EMPAQUES Y FELPAS

BRK 8065	
SKU	Características
MX67049	<p>Empaque hongo, base de 6.5 mm rollo de 200 m.                      Serie: AB V y AB P                      Material: Caucho                      Acabado: Negro / Base naranja</p>

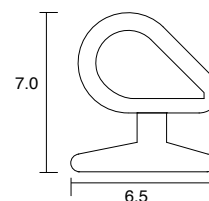
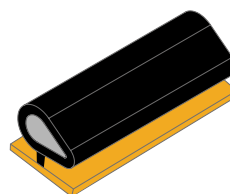

BRK 8066	
SKU	Características
MX67050	<p>Empaque hoja, base de 6.5 mm rollo de 200 m.                      Serie: AB V y AB P                      Material: PVC                      Acabado: Negro / Base naranja</p>

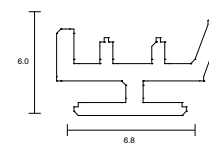
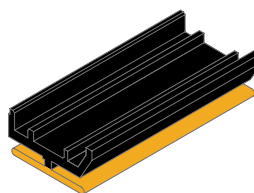

BRK 8071	
SKU	Características
MX67051	<p>Goma burbuja, base rígida.                      Base: 8.5 mm rollo de 200 m                      Serie: 1400 V y 1400 P                      Material: Caucho                      Acabado: Negro / Base naranja</p>

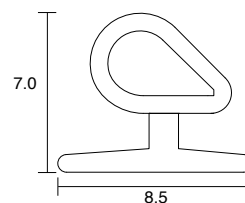
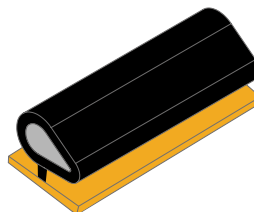

BRK 8072	
SKU	Características
MX67052	<p>Goma peine, base rígida.                      Base: 8.5 mm rollo de 200 m                      Serie: 1400 V y 1400 P                      Material: PVC                      Acabado: Negro / Base naranja</p>

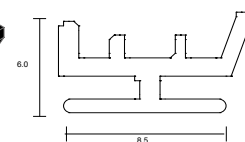
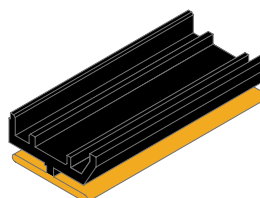

Los productos presentados en este catálogo, pueden ser modificados, derivados de nuestros procesos de innovación y mejora continua.

Todos nuestros productos cuentan con garantía. Las presentaciones de venta de nuestros productos (caja, blister, master, corrugado, etc.) pueden cambiar sin previo aviso.

Acotaciones en milímetros, se recomienda solicitar ficha técnica y verificar físicamente previo a instalación y perforación.

BRK 8076	
SKU	Características
MX66998	<p><b>Felpa con membrana intermedia.</b>                      Medidas: base 6.8 mm x 5 mm altura pelo x 7 mm                      Membrana: Rollo 200 m                      Serie: V4500, 80 y 10000                      Acabado: Negro</p>



**TecnoMX**

ASSA ABLOY

FF200N	
SKU	Características
MX65227	<p><b>Felpa con membrana intermedia.</b>                      Medidas: base 6.8 mm x 5 mm altura pelo x 6 mm                      Membrana: Rollo 200 m                      Serie: V4000, 70 y 4600                      Acabado: Negro y Gris</p>



# Síguenos en nuestras redes



@HerrajesBruken



@HerrajesBruken



@HerrajesBruken









HerrajesBruken

**¡NUEVO!**

**BRK 3556**

**CERRADURA DIGITAL de Manija para Perfil Angosto de Aluminio**

-  1 Cerradura
-  Para perfil angosto de aluminio con espesor de 25mm a 45mm
-  Huella Digital
-  Combinación Numérica
-  3 Baterías (No incluidas)
-  Hasta 40 usuarios por huella digital y clave

**Fuente de energía de emergencia:** Con batería externa de carga micro USB.



SKU	Descripción	ACABADO
MX67671	Cerradura Digital de Manija para perfil angosto de aluminio.	Satín
MX67670		Negro Mate

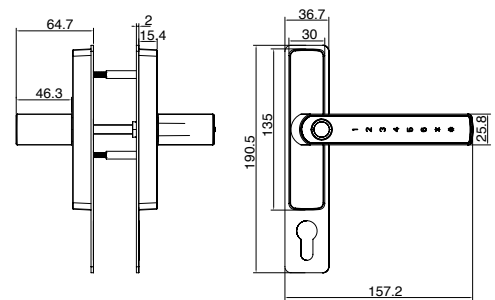

**KIT BRK 3656**

**KIT BRK 3556 SATÍN**

SKU	Componentes
MX67879	Cerradura Digital de Manija BRK3556 Cerradura Paleta de Embutir para Perfiles de Aluminio BRK 8080 Cilindro de 70 mm BRK4771

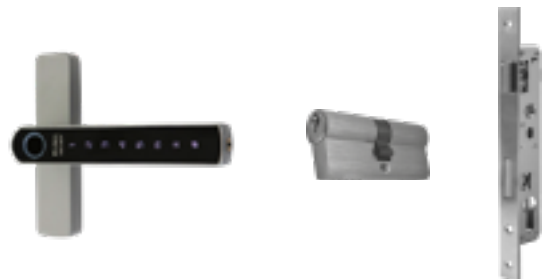

**KIT BRK 3556 NEGRO MATE**

SKU	Componentes
MX67880	Cerradura Digital de Manija BRK3556 Cerradura Paleta de Embutir para Perfiles de Aluminio BRK 8080 Cilindro de 70 mm BRK4771

