

axlent
i t a l y

axlent
i t a l y



2024

HERRAJES PARA VIDRIO TEMPLADO Y ALUMINIO

Zaragoza No. 2,
Col. Los Remedios,
Naucalpan de Juárez,
México, C.P. 53400

Tels.: 55 70 95 47 34 y 55 71 58 59 73

✉ atencion.italiamed@gmail.com

www.herrajesaxcent.com

CONTENIDO

1

Cerradores
Sistemas corredizos
Cerraduras • Chapas

3

Jaladeras • Clips
Bisagras • Separadores

13

Soportes • Conectores
Complementos
Tapones • Bridas • Tapas • Postes • Clips • Aletas
Mini Postes • Grapa rectangular • Grapa redonda

27

Herrajes para acceso
Punto de giro • Cerradura de esquina
Herrajes • Bisagras hidráulicas
Sistema hidráulico

43

Línea para barra estabilizadora
Conectores

48

Línea Black
Sistemas corredizos • Cerraduras • Jaladeras
Clips • Bisagras • Soportes • Conectores • Mini Poste
Grapa rectangular • Cerradura de esquina • Herrajes
Tapa para bisagra hidráulica de piso

50

Línea Gold
Sistemas corredizos • Jaladeras
Clips • Bisagras

61

63

Línea Aluminio
Carretillas • Jaladeras • Topes
Chapas • Escuadras • Bisagras
Tirador • Brazos de proyección

Contenido por clave

71

CARTA DE GARANTÍA

ITALIAMED, S.A. DE C.V., GARANTIZA este producto por el término de un año en todas sus partes, mano de obra y contra cualquier defecto de fabricación, apartir de la fecha en que el consumidor reciba el producto, considerando lo siguiente:

ESTA GARANTÍA NO ES EFECTIVA EN LOS SIGUIENTES CASOS:

- Cuando el producto ha sido utilizado en condiciones distintas a las normales.
- Cuando el producto no ha sido operado, manejado, instalado y limpiado correctamente.
- Cuando el producto ha sido alterado o reparado por externos a la empresa.

Se debe realizar la carta reclamo a **ITALIAMED, S.A. DE C.V.** o a su agente autorizado, dentro del periodo de garantía y a más tardar dentro de los primeros treinta (30) días calendario de ocurrido el incidente que motiva el reclamo.

LIMITACIONES DE LA GARANTÍA

ESTA GARANTÍA NO SERÁ VÁLIDA EN CASO DE NO SEGUIR LAS INDICACIONES SIGUIENTES:

MANTENIMIENTO DEL ACERO INOXIDABLE

Cuando aparecen trozos de corrosión después de algunos meses de instalado un producto, usualmente es resultado de un mal manejo, almacenaje o limpieza. Si aparecen manchas de corrosión, es posible restablecer el acabado con una simple limpieza. Los ingredientes de los productos de limpieza deben verificarse antes de emplearlos sobre el acero inoxidable, aún y cuando, estén catalogados como “limpiadores de acero inoxidable”. Debe evitarse el empleo de los limpiadores que contengan cloruros (base cloro) en su fórmula, o en su defecto, eliminarlos de la superficie mediante un vigoroso y concienzudo enjuagado para prevenir la corrosión. Los productos con ácido muriático o ácido clorhídrico nunca deben emplearse sobre el acero inoxidable, inclusive debe de evitarse usarlos cerca del mismo acero, ya que pueden provocar una rápida corrosión. Si la superficie del acero inoxidable ha sido contaminada con acero al carbón o hierro, la corrosión se desarrolla rápidamente y puede aparecer algunos días después de haber estado en exposición al ambiente exterior.

FACTORES QUE INFLUYEN EN LA CORROSIÓN:

1. Contaminación
 - i) Lluvia ácida.
 - ii) Dióxido de azufre y particulado.
2. Exposición a la sal costera.
3. Condiciones climáticas.
4. Mantenimiento.
5. Diseño.
 - i) Cavidades.
 - ii) Acabado.
6. Manejo y limpieza post-fabricación y colocación.

Para evitar el ataque de corrosión es conveniente tener en cuenta lo siguiente:

- Asegurar que las superficies se encuentren descontaminadas, eliminando toda traza de hierro, aluminio o restos abrasivos.
- No usar productos de limpieza a base de cloro.
- Utilizar solo agua y un paño húmedo.

Atentamente
ITALIAMED, S.A. DE C.V.

XH-073



Cerrador de puerta auto.

- Soporta: 120 kg.
- Acabado: Electrostático.
- Color: Plateado.

XH-072



Cerrador de puerta auto.

- Soporta: 80 kg.
- Acabado: Electrostático.
- Color: Plateado.

XH-071



Cerrador de puerta auto.

- Soporta: 65 kg.
- Acabado: Electrostático.
- Color: Plateado.

CERRADOR
INSTALADO

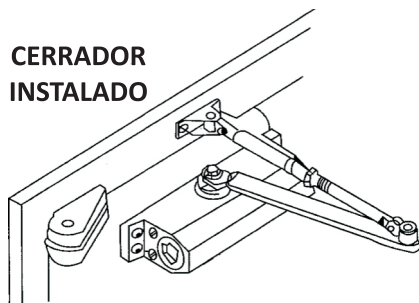

SOPORTE DE
CONEXIÓN

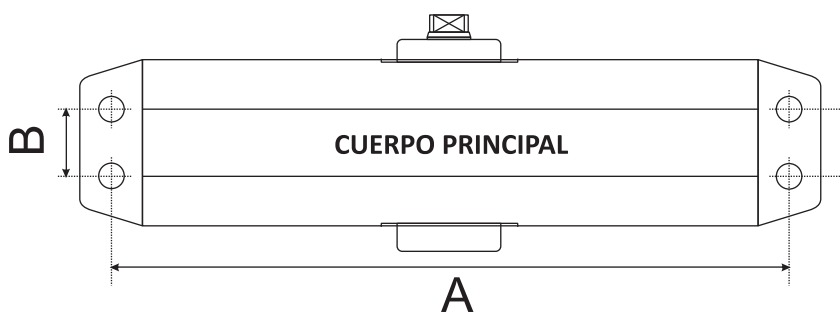
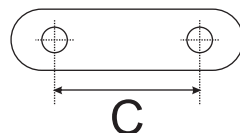

Modelo	A	B	C
XH-073	230	19	45
XH-072	188	20	40.5
XH-071	165	20	40.5

Medidas en mm.

KH01

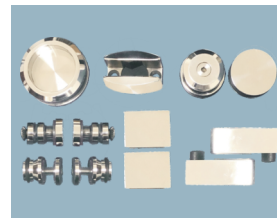

Sistema corredizo sin tubo.

- Para: 8-10 mm.
- Material: Acero inox. 304.
- Acabado: Cromo.

KH01-Z

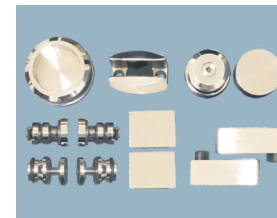

Sistema corredizo sin tubo.

- Para: 8-10 mm.
- Material: Zamac.
- Acabado: Cromo.

KH01Z-S

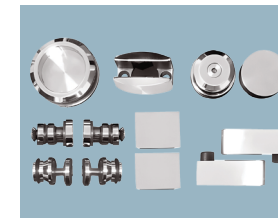

Sistema corredizo sin tubo.

- Para: 8-10 mm.
- Material: Zamac.
- Acabado: Satín.

KH01-S



Sistema corredizo sin tubo.

- Para: 8-10 mm.
- Material: Acero inox. 304
- Acabado: Satín.

KH02



Sistema corredizo sin tubo.

- Para: 10-12 mm.
- Material: Acero inox. 304
- Acabado: Satín.

KH03

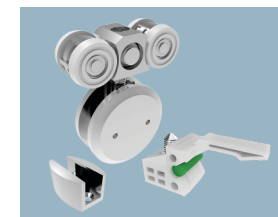

Sistema corredizo con resaque sin tubo.

- Para: 8-12 mm.
- Material: Acero inox. 304
- Acabado: Satín.

B023

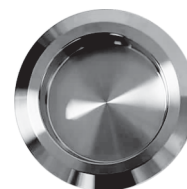

Jaladera redonda.

- Para: 6-10 mm.
- Material: Acero inox. 304
- Acabado: Satín.

N0115

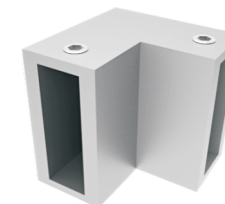

Escuadra para sistema corredizo.

- Material: Acero inox. 304
- Acabado: Satín.

N0115-C

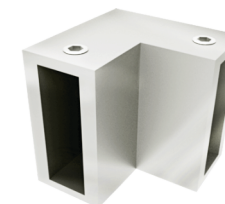

Escuadra para sistema corredizo.

- Material: Acero inox. 304
- Acabado: Cromo.

N0208

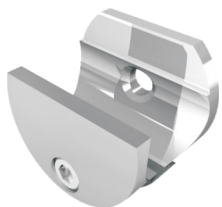

Soporte a muro de sistema corredizo.

- Material: Acero inox. 304
- Acabado: Satín.

O15-S

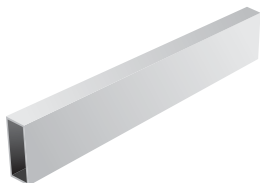

Tubo (riel) cuadrado para sistema corredizo

- Tamaño: 10 x 30 mm
- Largo: 1.5 m
- Calibre: 16
- Compatible: KH01/KH01Z/KH01S
- Material: Acero inox. 304.
- Acabado: Satín.

O2-C • O2-S



Tubo (riel) cuadrado para sistema corredizo

- Tamaño: 10 x 30 mm
- Largo: 2 m
- Calibre: 16
- Compatible: KH01/KH01Z/KH01S
- Material: Acero inox. 304.
- Acabado: O2-C Cromo. O2-S Satín.

AL03



Riel cuadrado para sistema corredizo

- Largo: 3 m
- Compatible: KH03
- Material: Aluminio.
- Acabado: Satín.

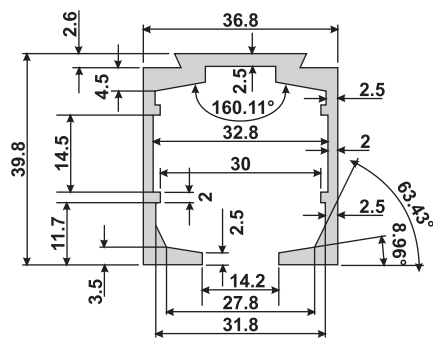

DEL CANTO DE LA HOJA AL CENTRO DEL BARRENO 100

Medidas en mm.

MODELOS KH01 / KH01-Z / KH01Z-S / KH01-S / KH01-B / KH01-G

Soporta: 70 kg Largo máximo: 1.8 m

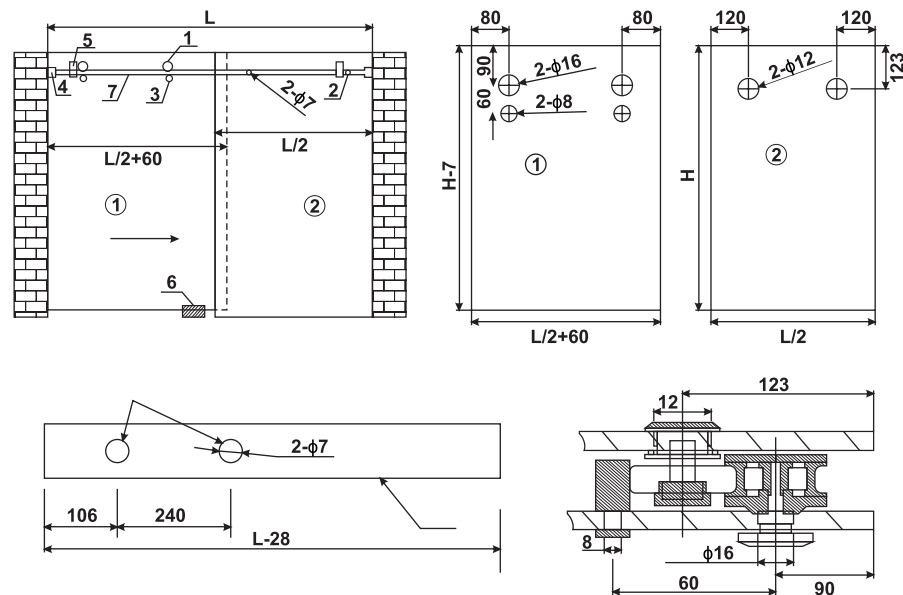

MODELOS KH02 / KH02-B

Soporta: 150 kg Largo máximo: 2.5 m

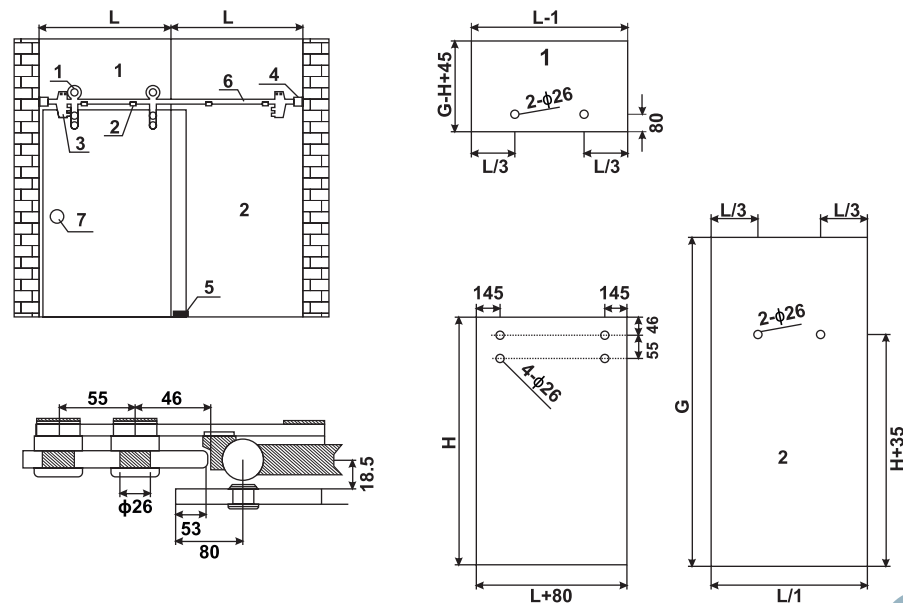

Medidas en mm.

MODELO KH03

Soporta: 90 kg Largo máximo: 2 m

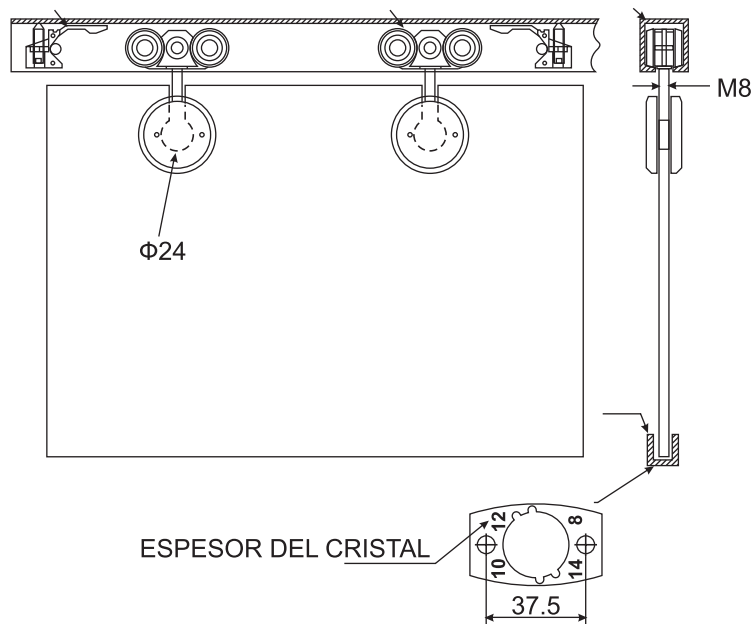

XH-82801



Cerradura de puerta de cristal de mariposa.

- Para: 8-12 mm.
- Material: Acero inox. 304.
- Acabado: Satín.

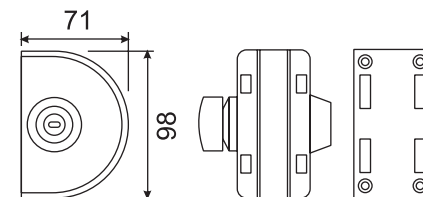

XH-82802



Cerradura de puerta de cristal plana.

- Para: 8-12 mm.
- Material: Acero inox. 304.
- Acabado: Satín.

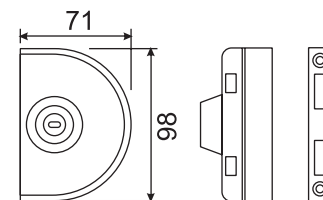

XH-82803



Cerradura de puerta de cristal doble de mariposa.

- Para: 8-12 mm.
- Material: Acero inox. 304.
- Acabado: Satín.

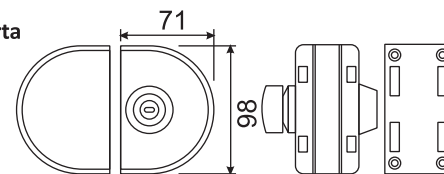

XH-82804



Cerradura de puerta de cristal doble plana.

- Para: 8-12 mm.
- Material: Acero inox. 304.
- Acabado: Satín.

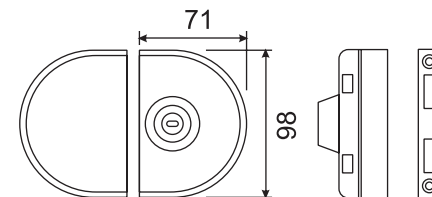

XH-82805



Cerradura de puerta de cristal de doble llave.

- Para: 8-12 mm.
- Material: Acero inox. 304.
- Acabado: Satín.

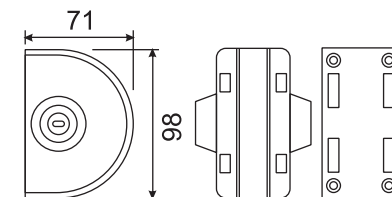

Medidas en mm.

XH-82806



Cerradura de puerta de cristal doble de doble llave.

- Para: 8-12 mm.
- Material: Acero inox. 304.
- Acabado: Satín.

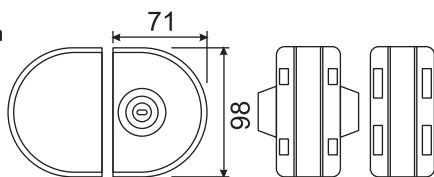

MODELOS XH-82801 AL XH-82806

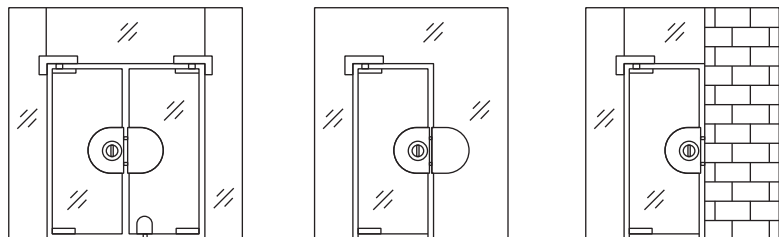
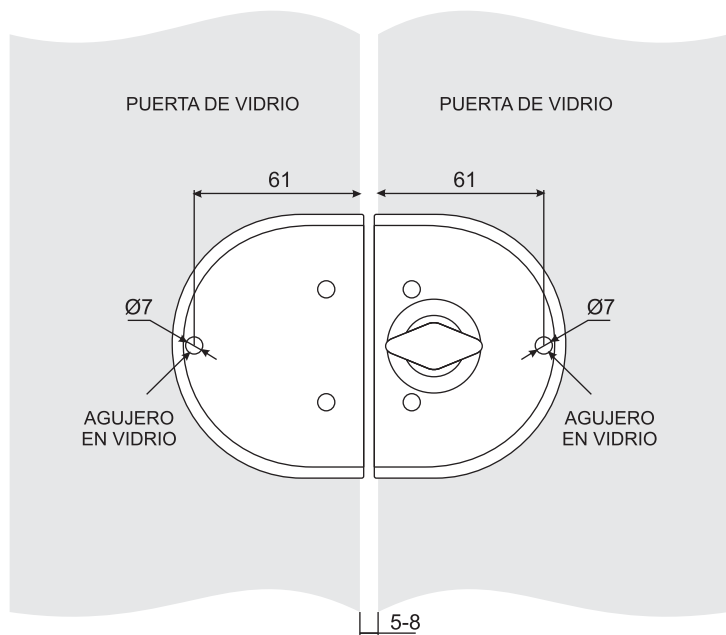

Medidas en mm.

XH-83101



Cerradura con mango.

- Para: 8-12 mm.
- Material: Acero inox. 304.
- Acabado: Satín.

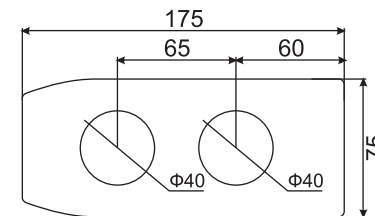

XH-83102P



Contra para cerradura con mango.

- Para: 8-12 mm.
- Material: Acero inox. 304.
- Acabado: Satín.

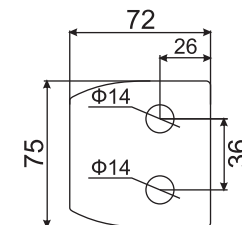

XH-83301



Cerradura de puerta corrediza.

- Para: 8-15 mm.
- Material: Acero inox. 304.
- Acabado: Satín.

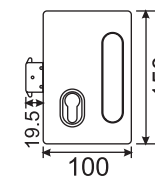

XH-83302



Cerradura de puerta corrediza doble.

- Para: 8-15 mm.
- Material: Acero inox. 304.
- Acabado: Satín.

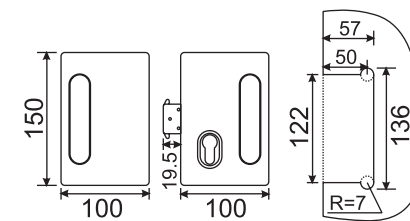

XH-84201



Cerradura de armario de cristal.

- Para: 6-12 mm.
- Material: Acero inox. 304.
- Acabado: Satín.

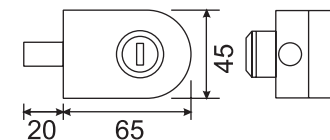

Medidas en mm.

XH-84202



Cerradura de armario de cristal doble.

- Para: 6-12 mm.
- Material: Acero inox. 304.
- Acabado: Satín.

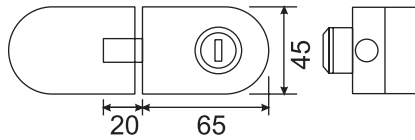

XH-84801



Cerradura de gancho para puerta.

- Para: 8-12 mm.
- Material: Acero inox. 304.
- Acabado: Satín.

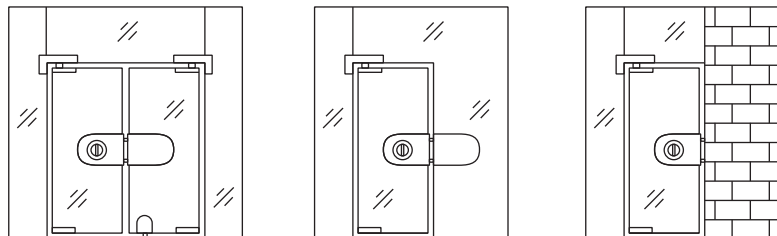
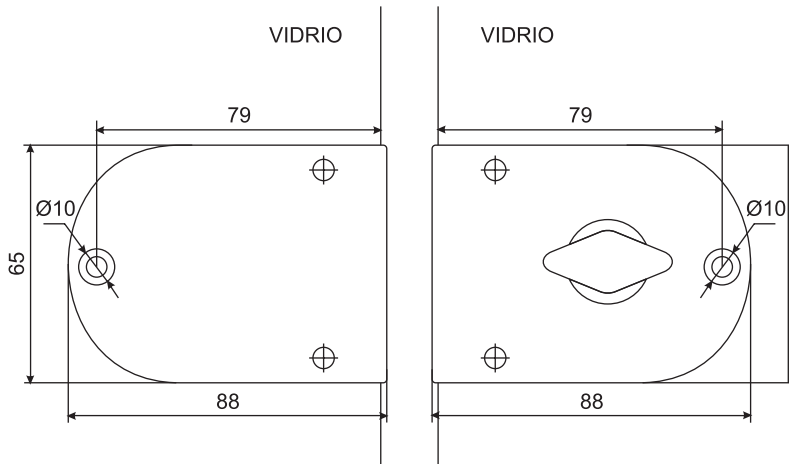
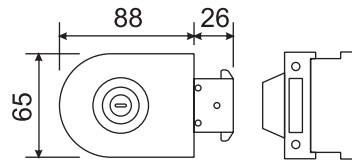

XH-84802P



Contracara para cerradura de gancho.

- Para: 8-12 mm.
- Material: Acero inox. 304.
- Acabado: Satín.

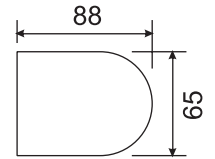

J101



Chapa cuadrada para vitrina.

- Para: 6-10 mm.
- Material: Zamac.
- Acabado: Satín.

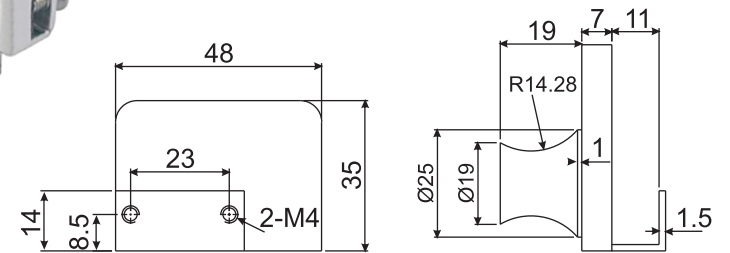

J102



Chapa ovalada para vitrina.

- Para: 6-10 mm.
- Material: Zamac.
- Acabado: Satín.

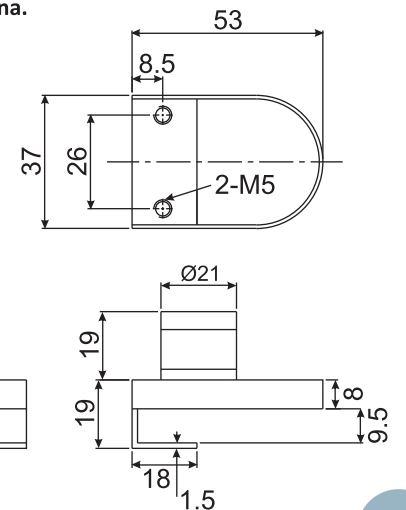

K-246-C • K-246-S



Jaladera 30*30.
 •Material: Aluminio.
 •Acabado:
 K-246-C Cromo.
 K-246-S Satín.

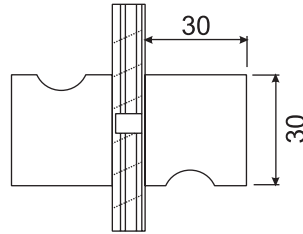

K-247-C • K-247-S



Jaladera 30*30.
 •Material: Aluminio.
 •Acabado:
 K-247-C Cromo.
 K-247-S Satín.

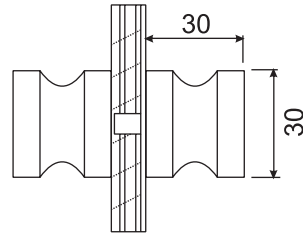

K-264-C



Jaladera 30*30.
 •Material: Aluminio.
 •Acabado: Cromo.

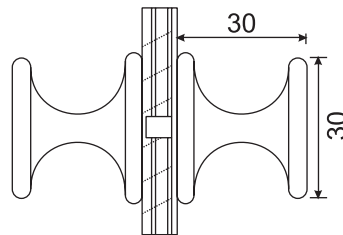

25*300-C



Jaladera de 30.
 •Para: 8-12 mm.
 •Material:
 Acero inox. 304.
 •Acabado: Cromo.

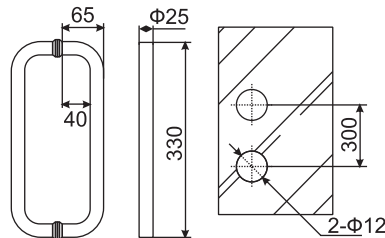

25*300-SN



Jaladera de 30.
 •Para: 8-12 mm.
 •Material:
 Acero inox. 304.
 •Acabado: Satín.

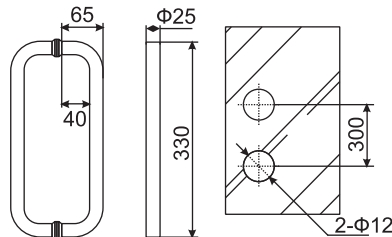

19*150-C



Jaladera de 15.
 •Para: 8-12 mm.
 •Material:
 Acero inox. 304.
 •Acabado: Cromo.

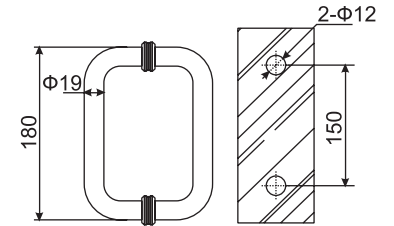

19*150-SN



Jaladera de 15.
 •Para: 8-12 mm.
 •Material:
 Acero inox. 304.
 •Acabado: Satín.

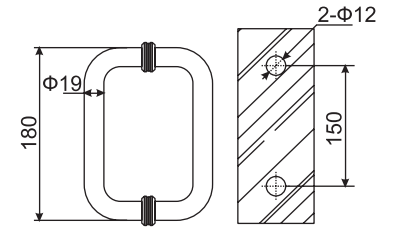

SH-250-50 • SH-250-90 • SH-250-120 • SH-250-150

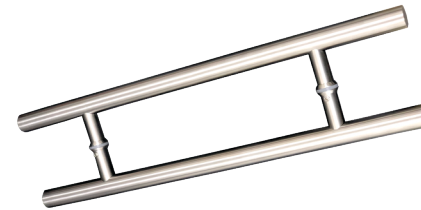

Jaladera tipo H de 1-1/4.
 •Material: Acero inox. 304.
 •Acabado: Satín.
 •SH-250-50 (50 cm) centros a 30 cm.
 SH-250-90 (90 cm) centros a 50 cm.
 SH-250-120 (120 cm) centros a 80 cm.
 SH-250-150 (150 cm) centros a 100 cm.



SH-530-20*45



Jaladera toallero 20*45
 •Material: Acero inox. 304.
 •Acabado: Satín.

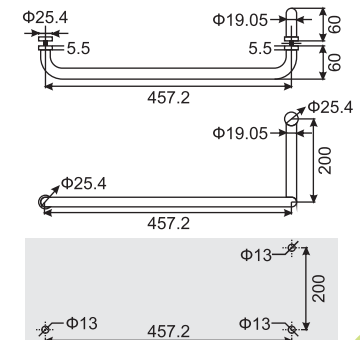

SH260



Barra de seguridad.

- De: 50 cm.
- Tubo: 1 1/4".
- Material: Acero inox. 304.
- Acabado: Satín.

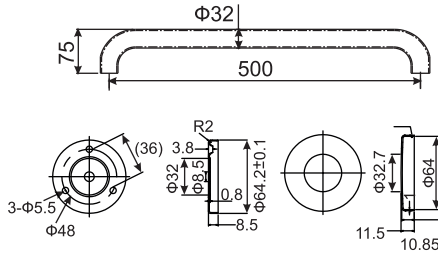

SH-250-K-120 • SH-250-K-150



Jaladera H con chapa.

- Material: Acero inox. 304.
- Acabado: Satín.
- Llave/mariposa.
- SH-250-K-120 (120 cm).
- SH-250-K-150 (150 cm).

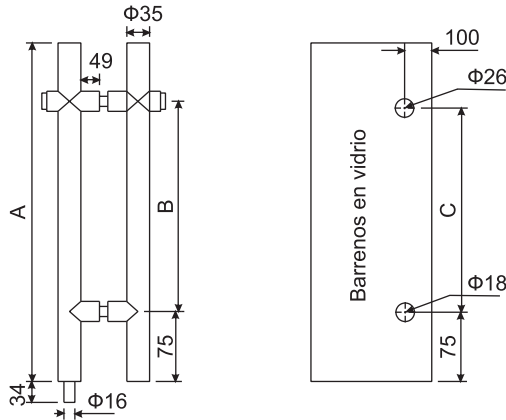

A	B	C
1200	925	925
1500	1125	1125

Medidas en mm.

K-121-12-C • K-121-12-S



Clip para cristal.

- Para: 8-12 mm.
- Soporta: 15 kg.
- Material: Zamac.
- Acabado: K-121-12-C Cromo. K-121-12-S Satín.

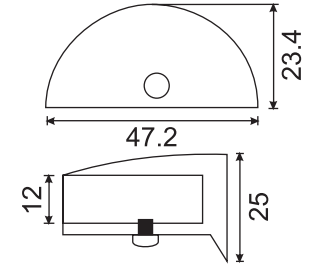

K-128-12-C • K-128-12-S



Clip para cristal.

- Para: 8-12 mm.
- Soporta: 15 kg.
- Material: Zamac.
- Acabado: K-128-12-C Cromo. K-128-12-S Satín.

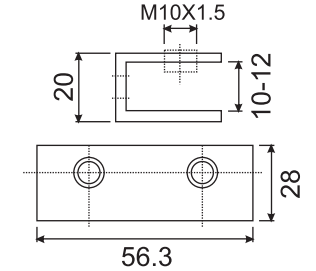

K-239-L

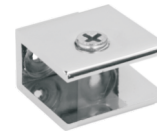

Clip para cristal.

- Para: 8-12 mm.
- Soporta: 15 kg.
- Material: Zamac.
- Acabado: Satín.

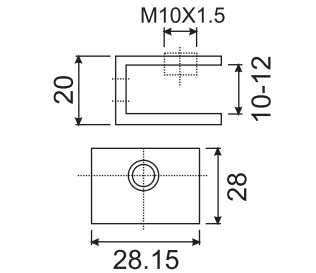

K-169-C • K-169-S



Clip.

- Para: 5-15 mm.
- Soporta: 25 kg.
- Material: Zamac.
- Acabado: K-169-C Cromo. K-169-S Satín.

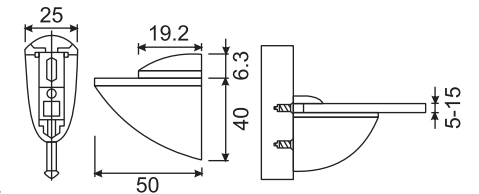

K-170-C • K-170-S



Clip.

- Para: 5-25 mm.
- Soporta: 35 kg.
- Material: Zamac.
- Acabado: K-170-C Cromo. K-170-S Satín.

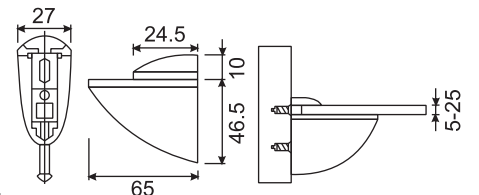

Medidas en mm.

K-170-1-C • K-170-1-S



Clip.

- Para: 5-30 mm.
- Soporta: 55 kg.
- Material: Zamac.
- Acabado:
K-170-1-C Cromo.
K-170-1-S Satín.

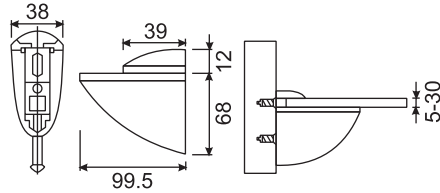

K-826



Clip.

- Para: 5-15 mm.
- Soporta: 20 kg.
- Material: Zamac.
- Acabado:
Níquel perlado.

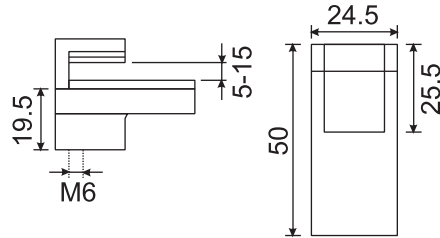

K-827



Clip.

- Para: 5-20 mm.
- Soporta: 20 kg.
- Material: Zamac.
- Acabado:
Níquel perlado.

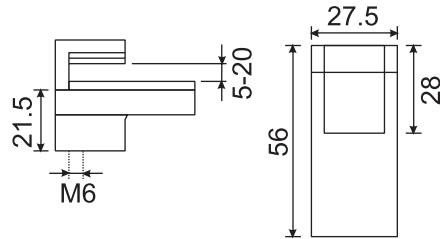

K-163



Clip.

- Para: 3-30 mm.
- Soporta: 35 kg.
- Material: Zamac.
- Acabado:
Níquel perlado.

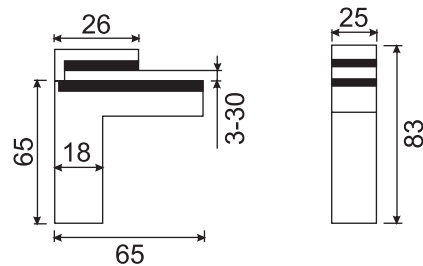

K-163-1



Clip.

- Para: 3-40 mm.
- Soporta: 55 kg.
- Material: Zamac.
- Acabado:
Níquel perlado.

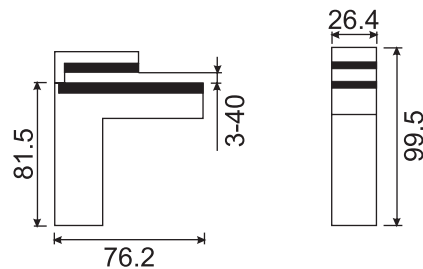

Medidas en mm.

K-165



Clip.

- Para: 3-15 mm.
- Soporta: 20 kg.
- Material: Zamac.
- Acabado: Satín.

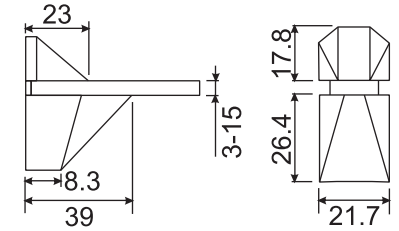

K-166

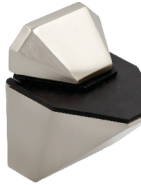

Clip.

- Para: 3-25 mm.
- Soporta: 35 kg.
- Material: Zamac.
- Acabado: Satín.

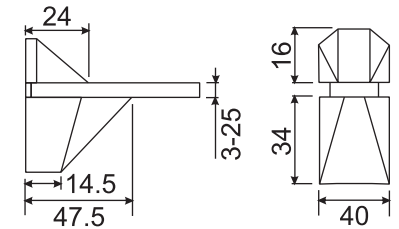

K-822



Clip.

- Para: 8 mm.
- Soporta: 15 kg.
- Material: Acero inox. 304.
- Acabado: Satín.
- Venta por par.

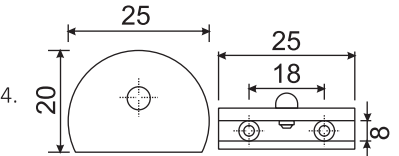

K-823



Clip.

- Para: 10 mm.
- Soporta: 15 kg.
- Material: Acero inox. 304.
- Acabado: Satín.
- Venta por par.

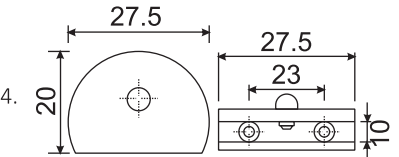

K-824



Clip.

- Para: 12 mm.
- Soporta: 15 kg.
- Material: Acero inox. 304.
- Acabado: Satín.
- Venta por par.

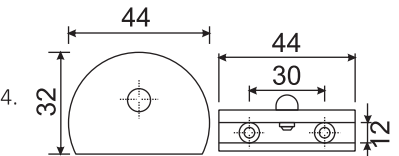

K-510-C • K-510



Clip 135°.

- Para: 8-10 mm.
- Soporta: 50 kg.
- Material: Acero inox. 304.
- Acabado:
K-510-C Cromo.
K-510 Satín.

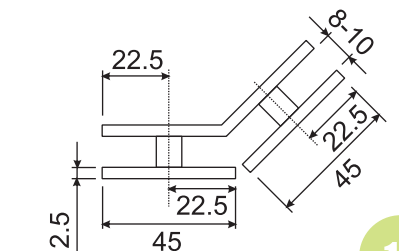

Medidas en mm.

K-512-C • K-512



Clip 180°.

- Para: 8-10 mm.
- Soporta: 50 kg.
- Material: Acero inox. 304.
- Acabado:
K-512-C Cromo.
K-512 Satín.

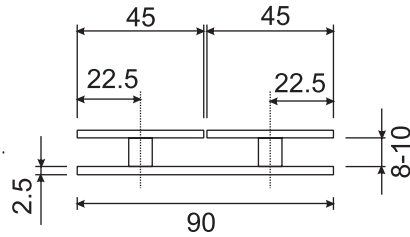

K-513



Clip.

- Para: 8-10 mm.
- Soporta: 50 kg.
- Material: Acero inox. 304.
- Acabado: Satín.

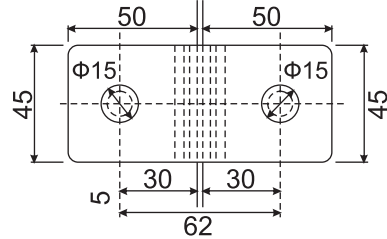

K-518-C • K-518



Clip.

- Para: 8-10 mm.
- Soporta: 50 kg.
- Material: Acero inox. 304.
- Acabado:
K-518-C Cromo.
K-518 Satín.

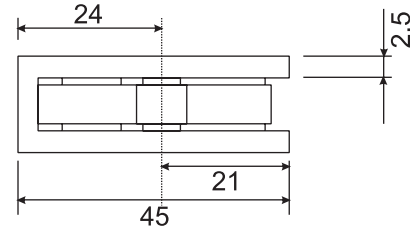

K-507-C • K-507



Clip 90°.

- Para: 8-10 mm.
- Soporta: 50 kg.
- Material: Acero inox. 304.
- Acabado:
K-507-C Cromo.
K-507 Satín.

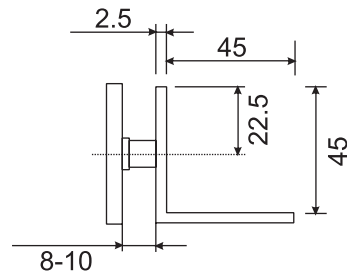

K-508-C • K-508



Clip 90°.

- Para: 8-10 mm.
- Soporta: 50 kg.
- Material: Acero inox. 304.
- Acabado:
K-508-C Cromo.
K-508 Satín.

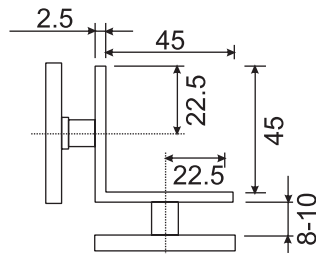

Medidas en mm.

K-858-C • K-858-S



Bisagra.

- Para: 6 mm.
- Soporta: 20 kg.
- Material: Zamac.
- Acabado:
K-858-C Cromo.
K-858-S Satín.

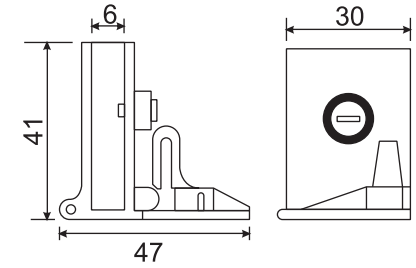

K-861-C • K-861-S



Bisagra.

- Para: 6-10 mm.
- Soporta: 35 kg.
- Material: Zamac.
- Acabado:
K-861-C Cromo.
K-861-S Satín.

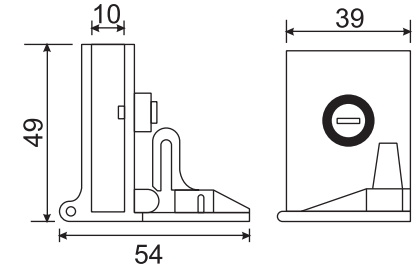

K-862-C • K-862-S



Bisagra.

- Para: 6-10 mm.
- Soporta: 50 kg.
- Material: Zamac.
- Acabado:
K-862-C Cromo.
K-862-S Satín.

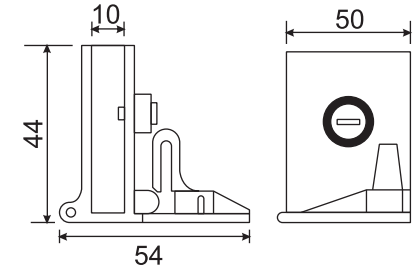

K-844



Bisagra plana.

- Para: 6-10 mm.
- Soporta: 25 kg.
- Material: Zamac.
- Acabado: Satín.

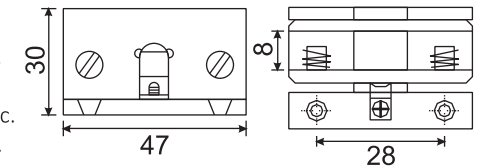

K-846



Bisagra curva.

- Para: 6-10 mm.
- Soporta: 25 kg.
- Material: Zamac.
- Acabado: Satín.

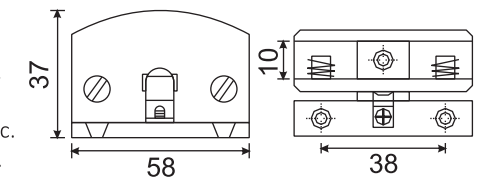

Medidas en mm.

K-174-10



- Bisagra.**
- Para: 6-10 mm.
 - Soporta: 35 kg.
 - Material: Acero inox. 304.
 - Acabado: Satín.

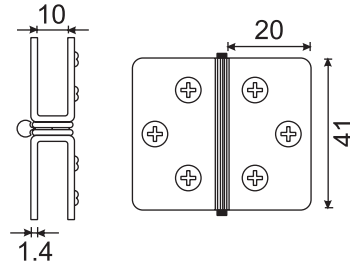

K-946



- Bisagra.**
- Para: 6-10 mm.
 - Soporta: 30 kg.
 - Material: Acero inox. 304.
 - Acabado: Satín.
 - Venta por set.

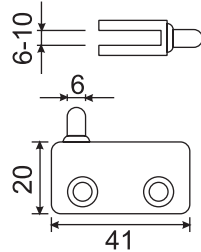

K-947



- Bisagra.**
- Para: 10-12 mm.
 - Soporta: 30 kg.
 - Material: Acero inox.
 - Acabado: Satín.
 - Venta por set.

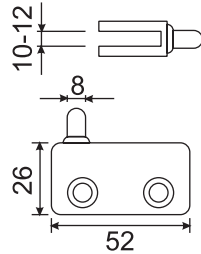

ZL6214-C • ZL6214-SN



- Bisagra muro a cristal centrada.**
- Para: 8-12 mm.
 - Soporta: 25 kg.
 - Material: Zamac.
 - Acabado:
ZL6214-C Cromo.
ZL6214-SN Satín.

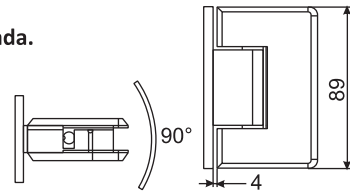

ZL6215-C • ZL6215-SN



- Bisagra muro a cristal desfasada.**
- Para: 8-12 mm.
 - Soporta: 25 kg.
 - Material: Zamac.
 - Acabado:
ZL6215-C Cromo.
ZL6215-SN Satín.

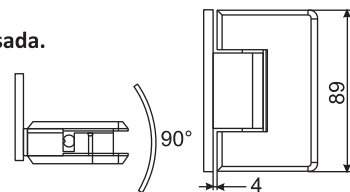

Medidas en mm.

MODELOS ZL6214 / ZL6215

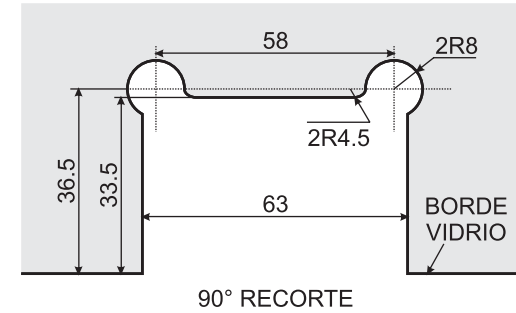

Z6216-C • Z6216-SN



- Bisagra cristal a cristal 135°.**
- Para: 8-12 mm.
 - Soporta: 25 kg.
 - Material: Zamac.
 - Acabado:
Z6216-C Cromo.
Z6216-SN Satín.

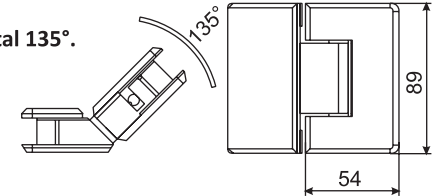

Z6217-C • Z6217-SN



- Bisagra cristal a cristal 180°.**
- Para: 8-12 mm.
 - Soporta: 25 kg.
 - Material: Zamac.
 - Acabado:
Z6217-C Cromo.
Z6217-SN Satín.

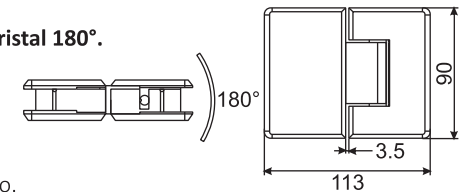

Z6218-C • Z6218-SN



- Bisagra cristal a cristal 90°.**
- Para: 8-12 mm.
 - Soporta: 25 kg.
 - Material: Zamac.
 - Acabado:
Z6218-C Cromo.
Z6218-SN Satín.

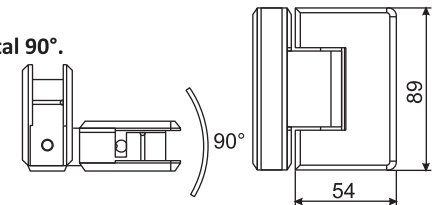

Medidas en mm.

MODELOS Z6216 / Z6217 / Z6218

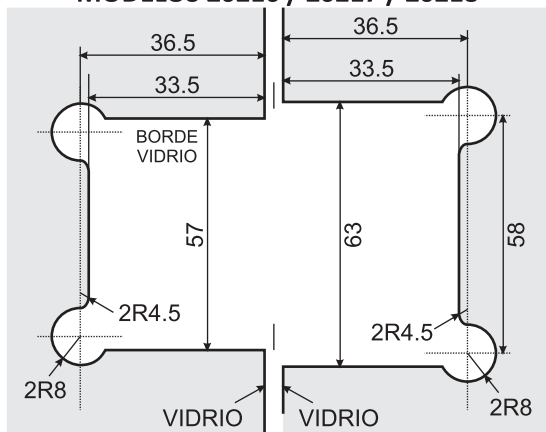

SH310-C • SH310-S



Bisagra muro a cristal desfasada.

- Para: 8-12 mm.
- Soporta: 25 kg.
- Material: Acero inox. 304.
- Acabado:
SH310-C Cromo.
SH310-S Satín.

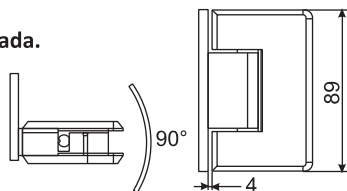

SH320-C • SH320-S



Bisagra muro a cristal centrada.

- Para: 8-12 mm.
- Soporta: 25 kg.
- Material: Acero inox. 304.
- Acabado:
SH320-C Cromo.
SH320-S Satín.

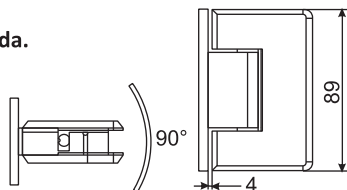

MODELOS SH310 / SH320

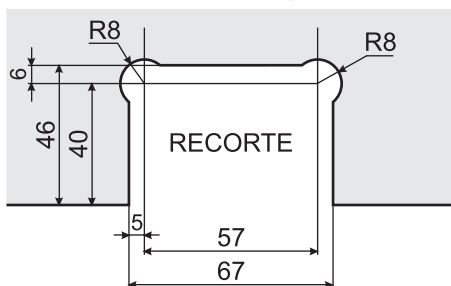

Medidas en mm.

SH330-C • SH330-S



Bisagra cristal a cristal 180°.

- Para: 8-12 mm.
- Soporta: 25 kg.
- Material:
Acero inox. 304.
- Acabado:
SH330-C Cromo.
SH330-S Satín.

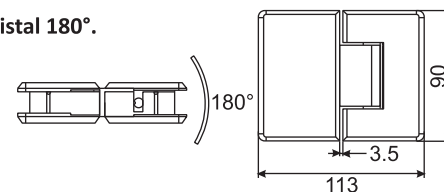

SH340-C • SH340-S



Bisagra cristal a cristal 135°.

- Para: 8-12 mm.
- Soporta: 25 kg.
- Material:
Acero inox. 304.
- Acabado:
SH340-C Cromo.
SH340-S Satín.

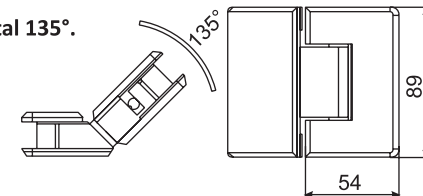

SH350-C • SH350-S



Bisagra cristal a cristal 90°.

- Para: 8-12 mm.
- Soporta: 25 kg.
- Material:
Acero inox. 304.
- Acabado:
SH350-C Cromo.
SH350-S Satín.

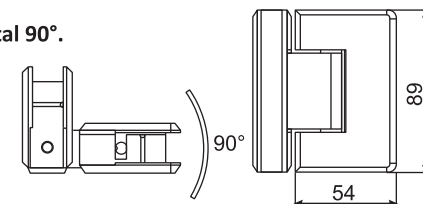

MODELOS SH330 / SH340 / SH350

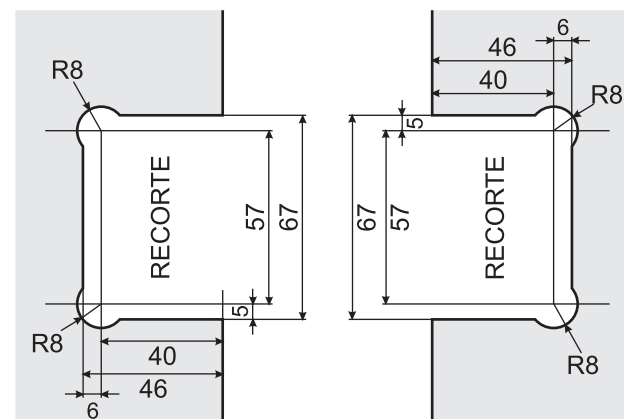

Medidas en mm.

SH300-C • SH300-S

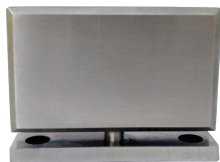

Bisagra pivotante.

- Para: 8-12 mm.
- Soporta: 25 kg.
- Material: Acero inox. 304.
- Acabado: SH300-C Cromo. SH300-S Satín.

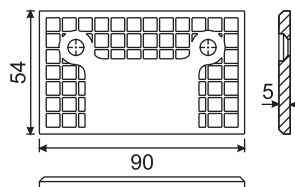

MODELOS SH300

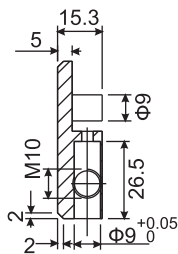
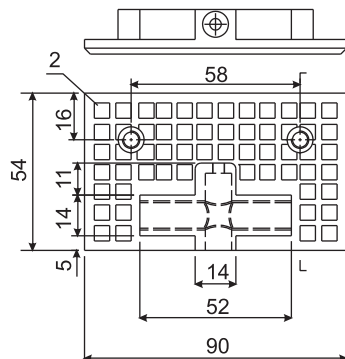
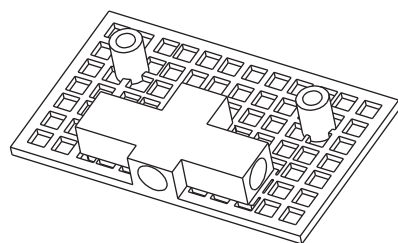
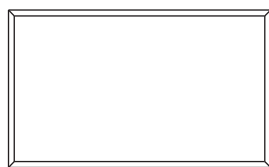
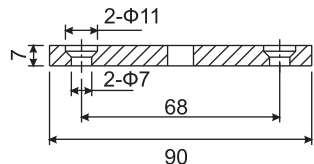
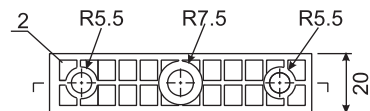
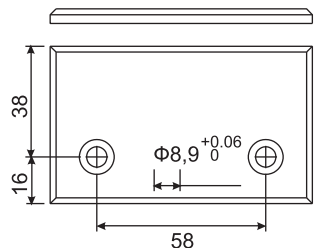
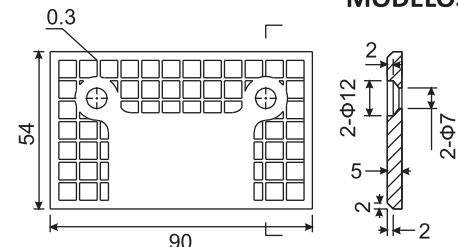

Medidas en mm.

K-258-1



Separador redondo hueco.

Varias medidas.

- Soporta: 30 kg.
- Material: Acero inox. 304.
- Acabado: Satín.

- k-258-1-19*20 19*20
- k-258-1-19*25 19*25
- k-258-1-19*30 19*30
- k-258-1-25*20 25*20
- k-258-1-25*25 25*25
- k-258-1-25*30 25*30
- k-258-1-25*40 25*40
- k-258-1-30*40 30*40
- k-258-1-30*50 30*50
- k-258-1-30*60 30*60
- k-258-1-30*70 30*70
- k-258-1-40*40 40*40
- k-258-1-40*50 40*50
- k-258-1-40*60 40*60
- k-258-1-40*70 40*70

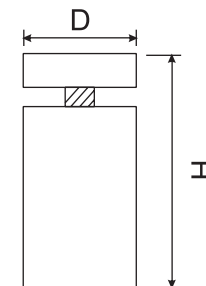

D \ H	20	25	30	40	50	60	70	80	100
12	20	25	30	40	50	60	70	80	100
16	20	25	30	40	50	60	70	80	100
19	20	25	30	40	50	60	70	80	100
25	20	25	30	40	50	60	70	80	100
30	20	25	30	40	50	60	70	80	100
40	20	25	30	40	50	60	70	80	100

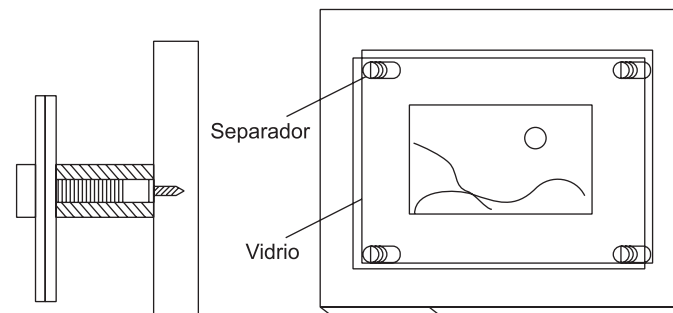

Medidas en mm.

C-005



**Soporte de fijación
doble tapa.**

- Para: 8-12 mm.
- Soporta: 30 kg.
- Material: Acero inox. 304.
- Acabado: Satín.

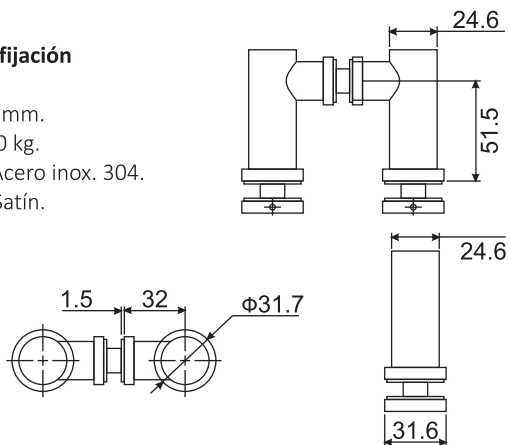

C-003



**Soporte de fijación
muro a cristal con taquete.**

- Para: 8-12 mm.
- Soporta: 30 kg.
- Material: Acero inox. 304.
- Acabado: Satín.

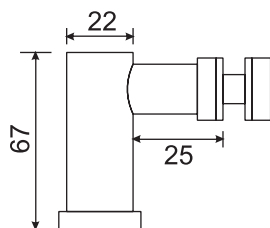

C-001



**Soporte de fijación
cristal a cristal.**

- Para: 8-12 mm.
- Soporta: 30 kg.
- Material: Acero inox. 304.
- Acabado: Satín.

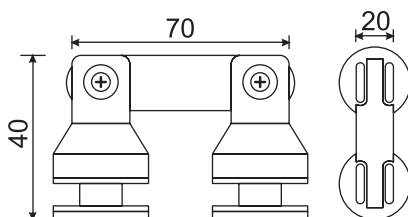

K-957-25



Soporte para tubo.

- Para: 1 pulgada.
- Soporta: 20 kg.
- Material: Acero inox. 304.
- Acabado: Satín.
- Venta por par.

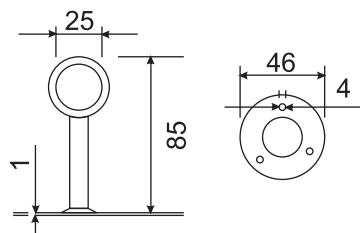

Medidas en mm.

K-957-32



Soporte para tubo.

- Para: 1.5 pulgadas.
- Soporta: 20 kg.
- Material: Acero inox. 304.
- Acabado: Satín.
- Venta por par.

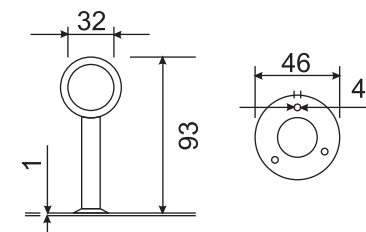

K-961-25



Soporte para tubo.

- Para: 1 pulgada.
- Soporta: 20 kg.
- Material: Acero inox. 304.
- Acabado: Satín.
- Venta por par.

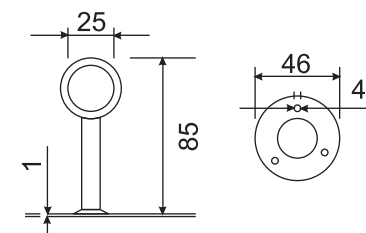

K-961-32



Soporte para tubo.

- Para: 1.5 pulgadas.
- Soporta: 20 kg.
- Material: Acero inox. 304.
- Acabado: Satín.
- Venta por par.

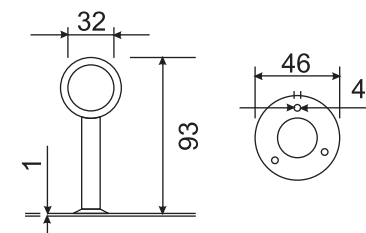

M063



Conector intermedio poste.

- Tubo: 1/2".
- Material: Acero inox. 304.
- Acabado: Satín.

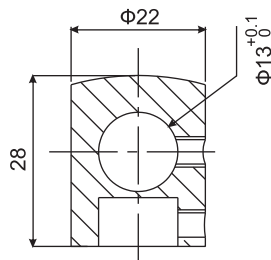

M063-L



Conector izquierdo poste.

- Tubo: 1/2".
- Material: Acero inox. 304.
- Acabado: Satín.

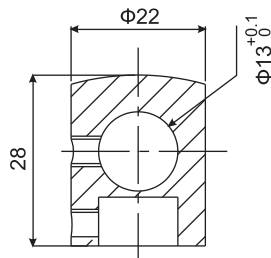

M063-R



Conector derecho poste.

- Tubo: 1/2".
- Material: Acero inox. 304.
- Acabado: Satín.

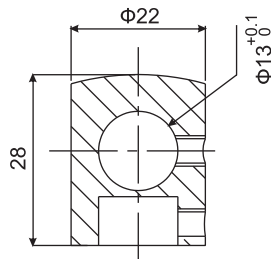

MODELOS M063 / M063-L / M063-R

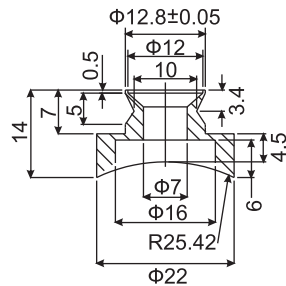
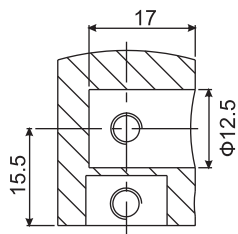
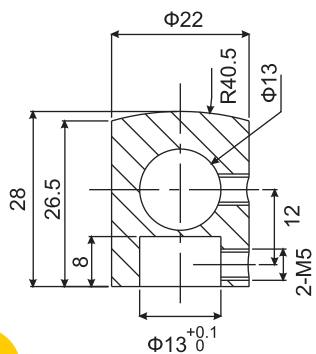

Medidas en mm.

PH800-1-SN



Conector muro a tubo.

- Soporta: 30 kg.
- Material: Acero inox. 304.
- Acabado: Satín.

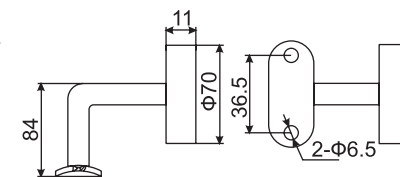

PH804-1-SN



Conector muro a tubo.

- Soporta: 30 kg.
- Material: Acero inox. 304.
- Acabado: Satín.

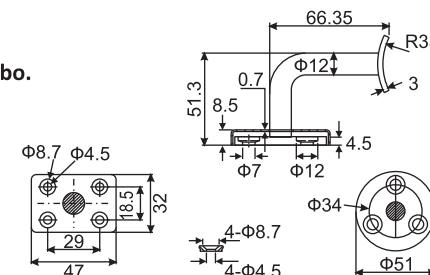

PH800-SN



Conector vidrio a tubo.

- Para: 8-12 mm.
- Soporta: 30 kg.
- Material: Acero inox. 304.
- Acabado: Satín.

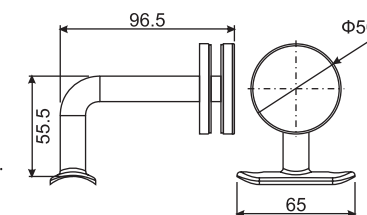

PH804-SN



Conector vidrio a tubo.

- Para: 8-12 mm.
- Soporta: 30 kg.
- Material: Acero inox. 304.
- Acabado: Satín.

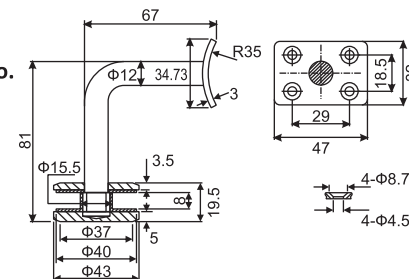

C011

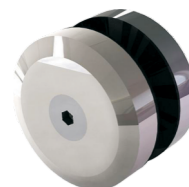

Conector vidrio a vidrio.

- Material: Acero inox. 304.
- Acabado: Satín.

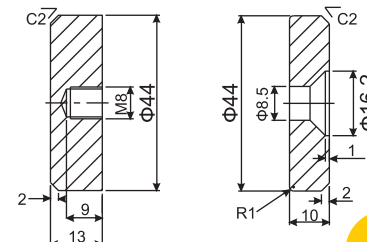

Medidas en mm.

ALC011



Botón estabilizador vidrio a vidrio.

- *Material:* Aluminio.
- *Acabado:* Satín.

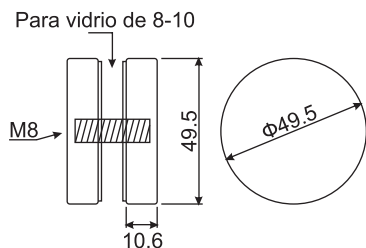

M112



Conector tubo a tubo 180°.

- *Para:* Tubo de 2".
- *Material:* Acero inox. 304.
- *Acabado:* Satín.

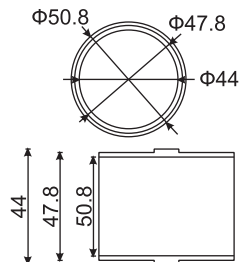

M312



Conector tubo a tubo 180°.

- *Para:* Tubo de 1.5".
- *Material:* Acero inox. 304.
- *Acabado:* Satín.

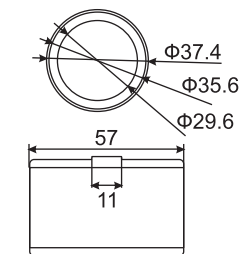

M309



Conector tubo a tubo articulado de 90° a 180°.

- *Para:* Tubo de 1.5".
- *Material:* Acero inox. 304.
- *Acabado:* Satín.

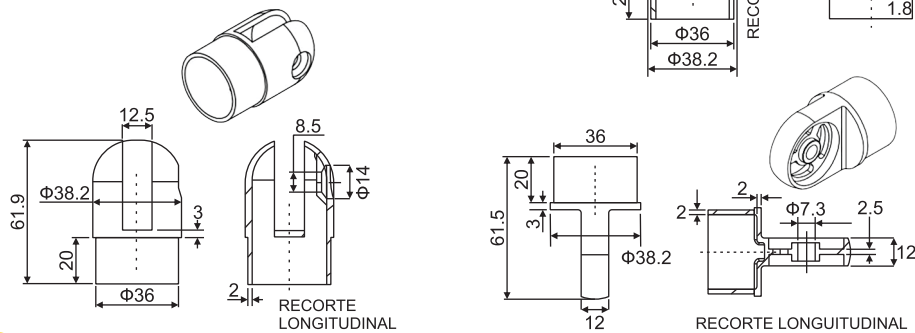
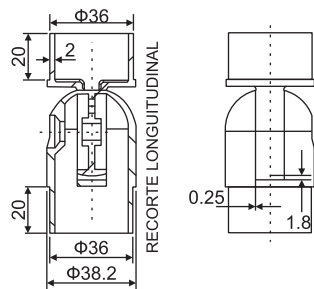

Medidas en mm.

M109



Conector tubo a tubo articulado de 90° a 180°.

- *Para:* Tubo de 2".
- *Material:* Acero inox. 304.
- *Acabado:* Satín.

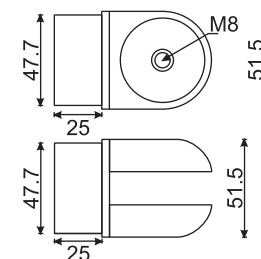

M101



Conector tubo a tubo 90°.

- *Para:* Tubo de 2".
- *Material:* Acero inox. 304.
- *Acabado:* Satín.

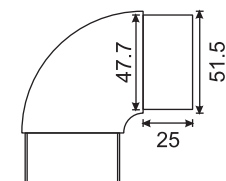

M301



Conector tubo a tubo 90°.

- *Para:* Tubo de 1.5".
- *Material:* Acero inox. 304.
- *Acabado:* Satín.

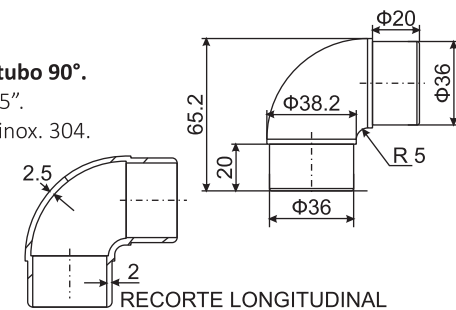

C012



Conector muro a vidrio.

- *Material:* Acero inox. 304.
- *Acabado:* Satín.

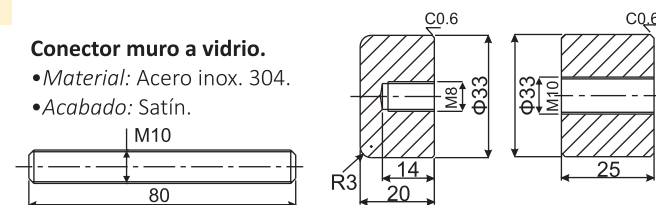

TC012



Taquete para conector C012.

- *Material:* Acero inox. 304.
- *Acabado:* Satín.

Medidas en mm.

C012-L



Conector muro a vidrio.
 •Material: Acero inox. 304.
 •Acabado: Satín.

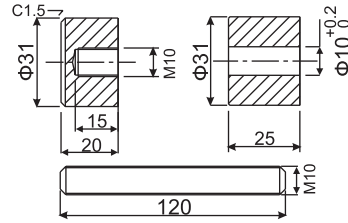

C013

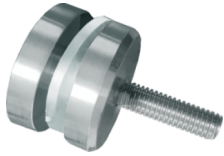

Conector muro a vidrio.
 •Material: Acero inox. 304.
 •Acabado: Satín.

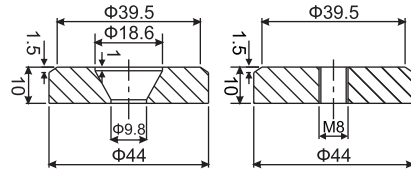

C014

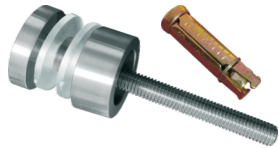

Conector muro a vidrio con taquete.
 •Material: Acero inox. 304.
 •Acabado: Satín.

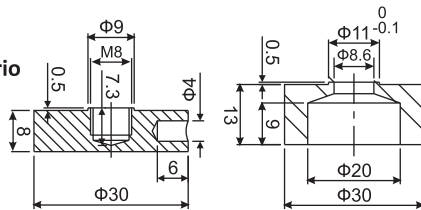

M126



Conector articulado para barandal.
 •Para: Tubo de 2".
 •Material: Acero inox. 304.
 •Acabado: Satín.

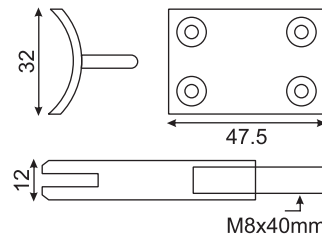

M125H

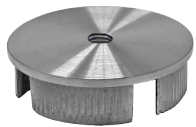

Tapón para conector de rosca.
 •Para: Tubo de 2".
 •Material: Acero inox. 304.
 •Acabado: Satín.

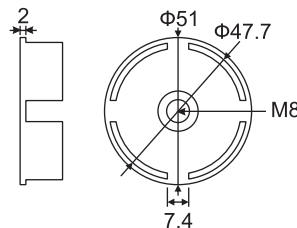

M125

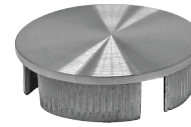

Tapón para poste.
 •Para: Tubo de 2".
 •Material: Acero inox. 304.
 •Acabado: Satín.

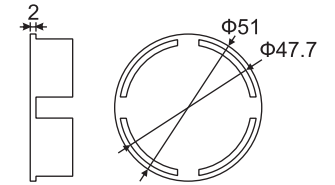

M325

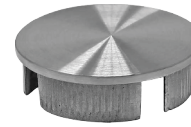

Tapón para poste.
 •Para: Tubo de 1.5".
 •Material: Acero inox. 304.
 •Acabado: Satín.

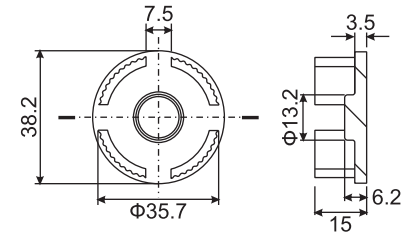

M075



Brida sin cuello.
 •Para: Tubo de 2".
 •Material: Acero inox. 304.
 •Acabado: Satín.

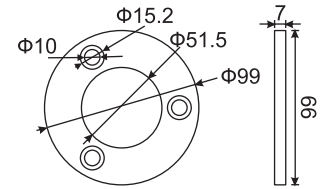

PH001-SN



Brida con cuello para tubo.
 •Para: 1.5".
 •Material: Acero inox. 304.
 •Acabado: Satín.

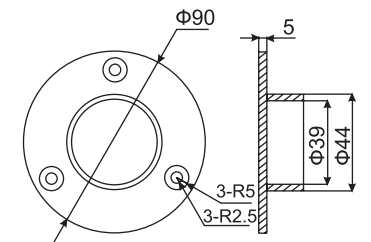

PH002-SN



Brida con cuello para tubo.
 •Para: 2".
 •Material: Acero inox. 304.
 •Acabado: Satín.

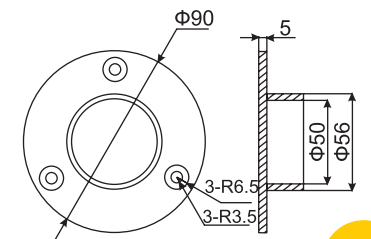

M090

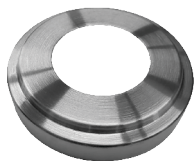

Tapa de base redonda para poste.

- Para: Tubo de 2".
- Material: Acero inox. 304.
- Acabado: Satín.

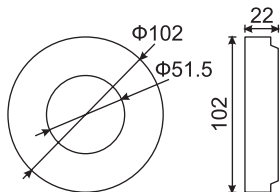

PH003-SN

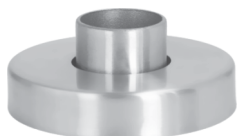

Poste para barandal con cuello y tapa.

- Para: 1.5".
- Material: Acero inox. 304.
- Acabado: Satín.

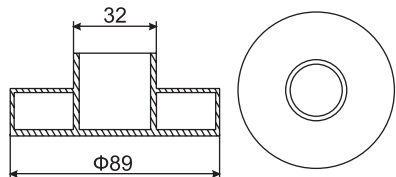

PH005-SN

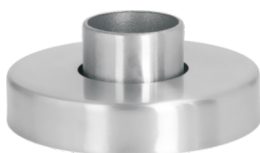

Poste para barandal con cuello y tapa.

- Para: 2".
- Material: Acero inox. 304.
- Acabado: Satín.

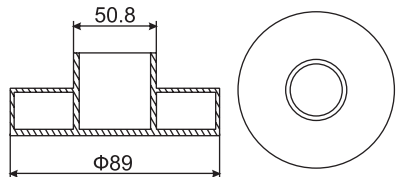

K-869-C • K-869-S

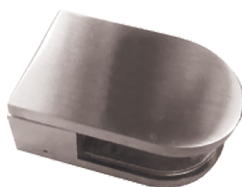

Clip de fijación base curva.

- Para: 6-10 mm.
- Soporta: 30 kg.
- Material: Acero inox. 304.
- Acabado: K-869-C Cromo. K-869-S Satín.

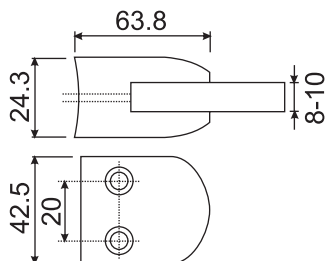

K-870-C • K-870-S

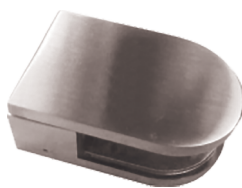

Clip de fijación base plana.

- Para: 6-10 mm.
- Soporta: 30 kg.
- Material: Acero inox. 304.
- Acabado: K-870-C Cromo. K-870-S Satín.

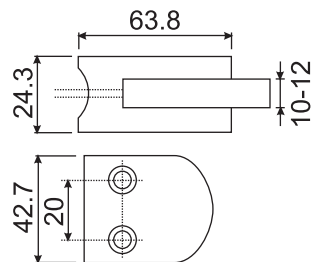

K-869Z-S



Clip de fijación ancho base curva.

- Para: 6-12 mm.
- Soporta: 30 kg.
- Material: Zamac.
- Acabado: Satín.

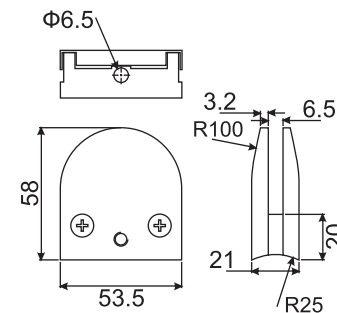

K-870Z-S



Clip de fijación ancho base plana.

- Para: 6-12 mm.
- Soporta: 30 kg.
- Material: Zamac.
- Acabado: Satín.

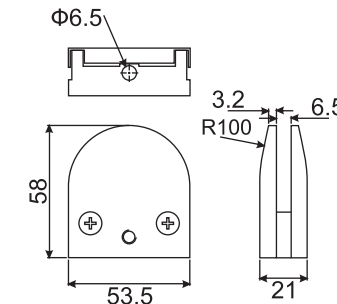

P-871



Clip de fijación ancho base curva.

- Para: 6-12 mm.
- Soporta: 30 kg.
- Material: Zamac.
- Acabado: Satín.

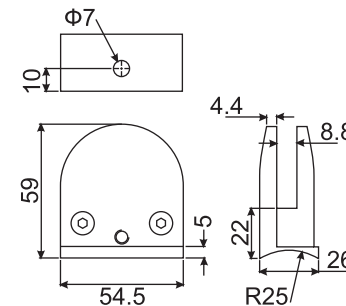

P-872



Clip de fijación ancho base plana.

- Para: 6-12 mm.
- Soporta: 30 kg.
- Material: Zamac.
- Acabado: Satín.

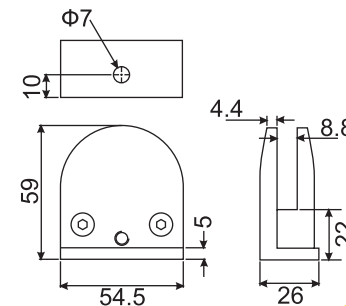

F001



Aleta.

- De: 2.5 m.
- Para: 10 mm.
- Material: PVC.

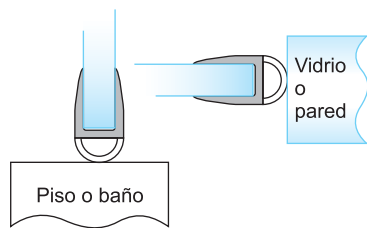

F002



Aleta.

- De: 2.5 m.
- Para: 10 mm.
- Material: PVC.

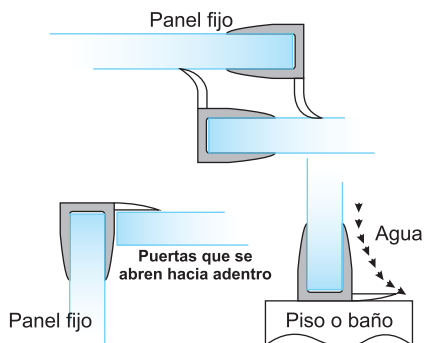

F004



Aleta.

- De: 2.5 m.
- Para: 6-15 mm.
- Material: PVC.

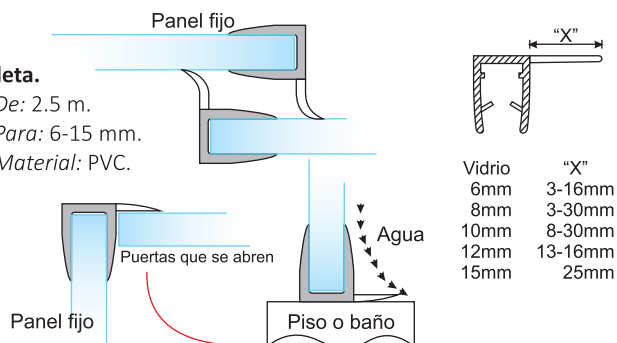

F005

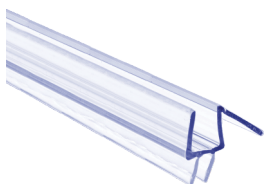

Aleta.

- De: 2.5 m.
- Para: 8-12 mm.
- Material: PVC.

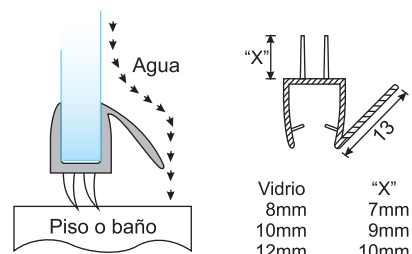

Medidas en mm.

C101

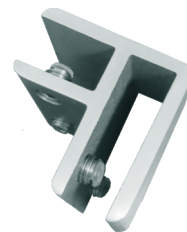

Conector rectangular de esquina.

- Para: 8-10 mm.
- Material: Aluminio.
- Acabado: Satín.

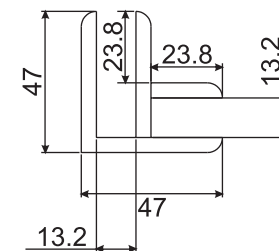

C102



Conector vidrio a vidrio.

- Para: 8-10 mm.
- Material: Acero inox. 304.
- Acabado: Satín.

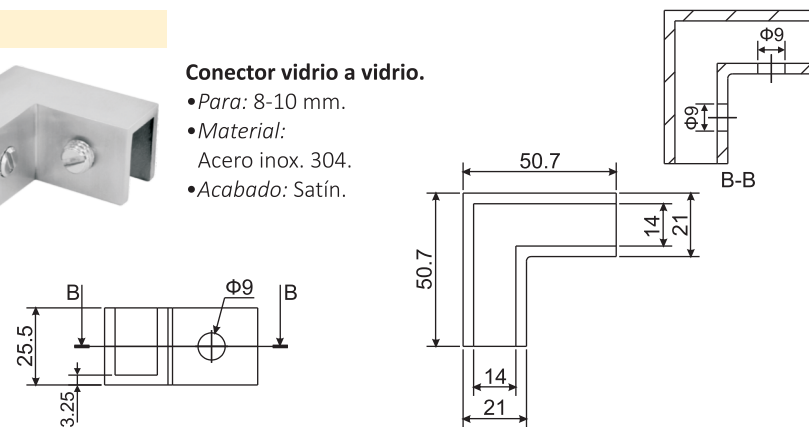

C103

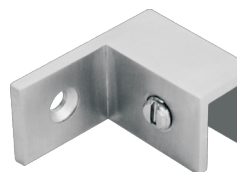

Conector muro a vidrio derecho.

- Para: 8-10 mm.
- Material: Acero inox. 304.
- Acabado: Satín.

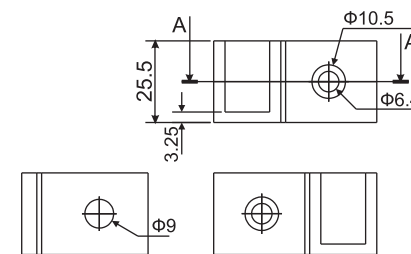

C104

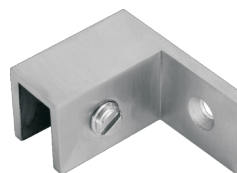

Conector muro a vidrio izquierdo.

- Para: 8-10 mm.
- Material: Acero inox. 304.
- Acabado: Satín.

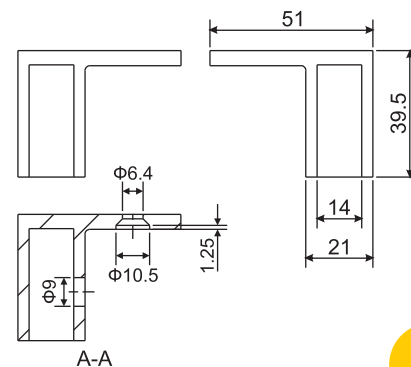

Medidas en mm.

C105

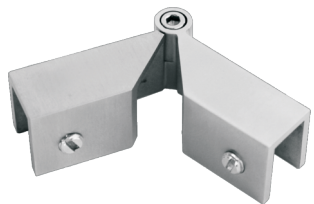

Conector ajustable.

- Para: 8-10 mm.
- Material: Acero inox. 304.
- Acabado: Satín.

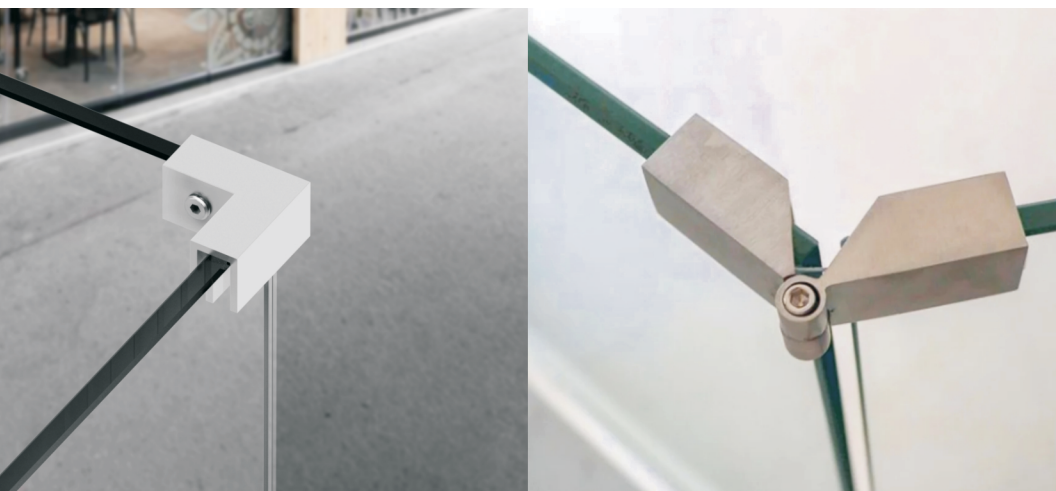
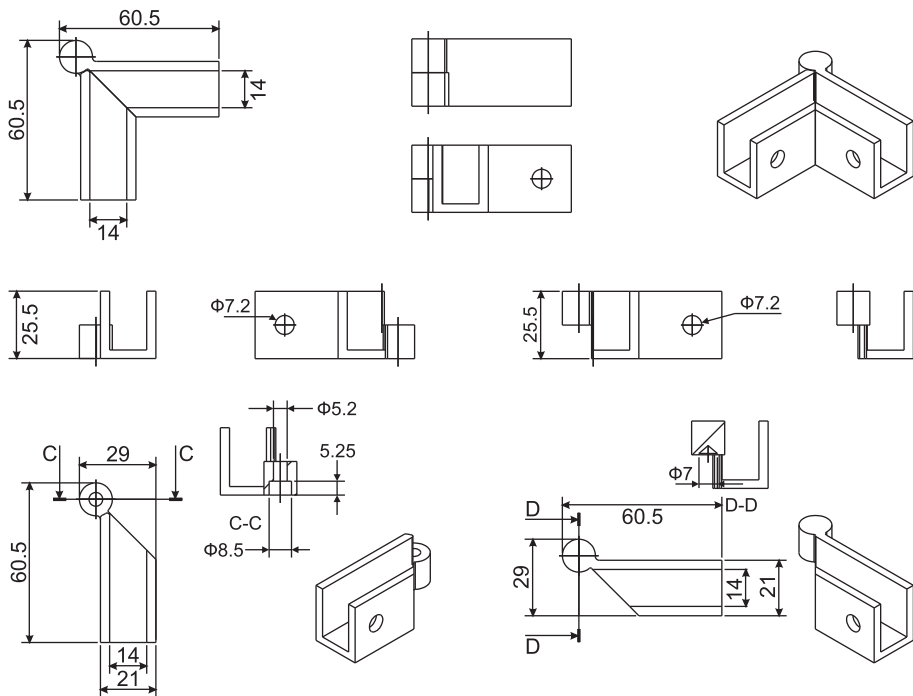

M100

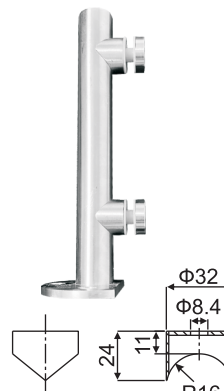

Mini Poste.

- De: 25 cm.
- Para: 8-12 mm.
- Diámetro: 1 1/4".
- Material: Acero inox. 304.
- Acabado: Satín.

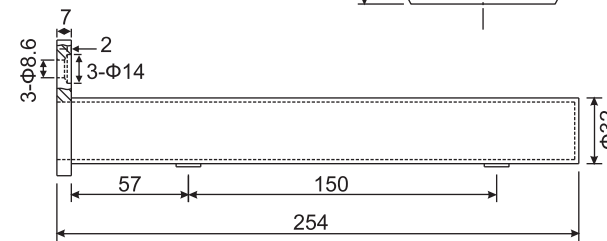
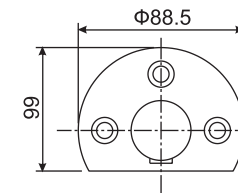

M100-L



Mini Poste.

- De: 50 cm.
- Para: 8-12 mm.
- Diámetro: 1 1/4".
- Material: Acero inox. 304.
- Acabado: Satín.

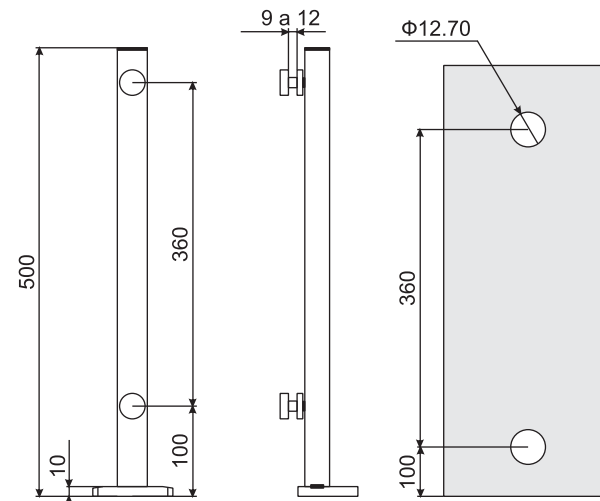
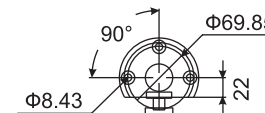

BARRENADO

Medidas en mm.

GRAPA RECTANGULAR

M155



Grapa rectangular.

- Para: 8-12 mm.
- Material: Acero inox. 304.
- Acabado: Satin.

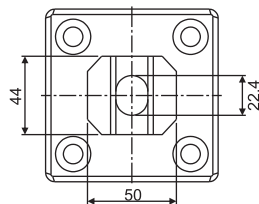
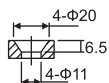
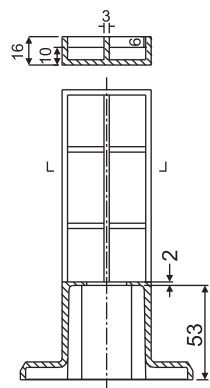
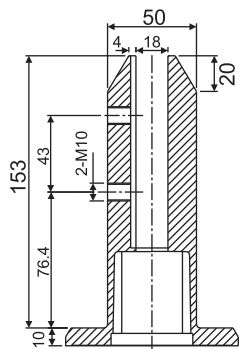
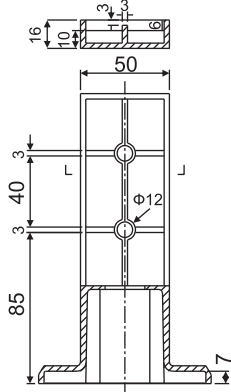
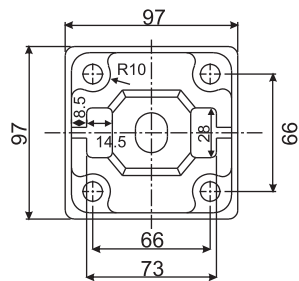

M156



Grapa redonda.

- Para: 8-12 mm.
- Material: Acero inox. 304.
- Acabado: Satin.

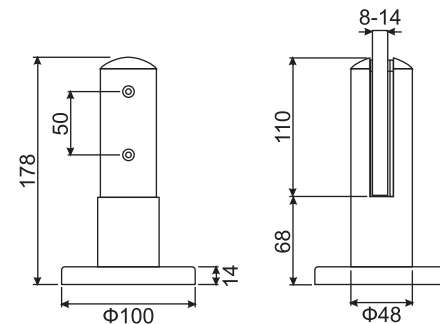

HN06

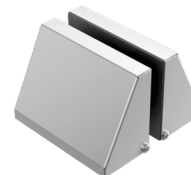

Conector.

- Para: 8-12 mm.
- Material: Acero inox. 304.
- Acabado: Satin.

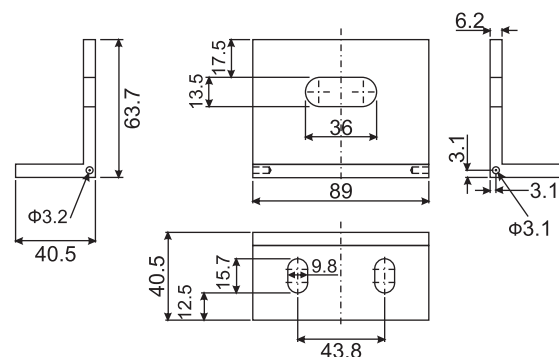
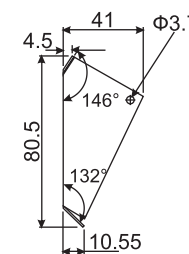
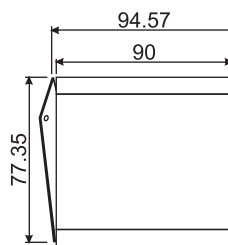
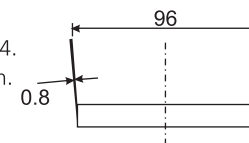

Medidas en mm.



A-607



Punto de giro superior.

- Material: Acero inox. 304.
- Acabado: Satín.

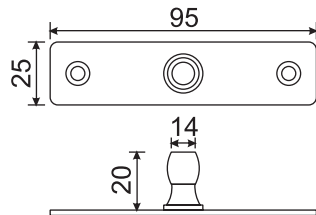

D-050



Cerradura de esquina

- Para: 8-12 mm.
- Material: Acero inox. 304.
- Acabado: Satín.

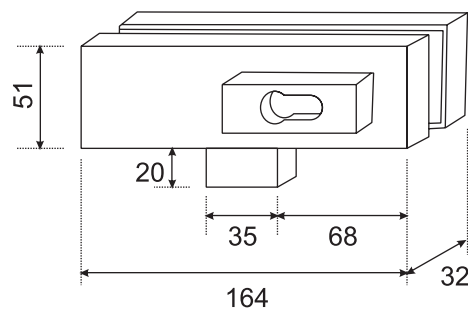

CORTE DE VIDRIO



Medidas en mm.

D-020



Herraje superior.

- Para: 8-12 mm.
- Material: Acero inox. 304.
- Acabado: Satín.

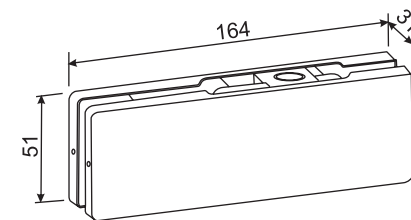

CORTE DE VIDRIO

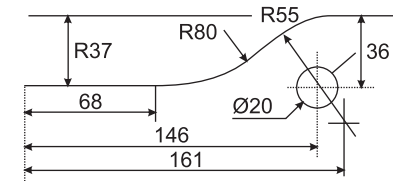

D-010



Herraje inferior.

- Para: 8-12 mm.
- Material: Acero inox. 304.
- Acabado: Satín.

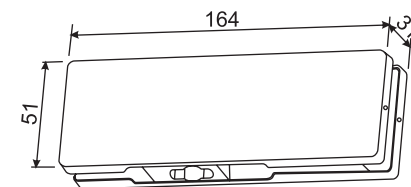

CORTE DE VIDRIO

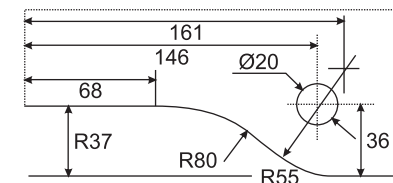

Medidas en mm.

B-322

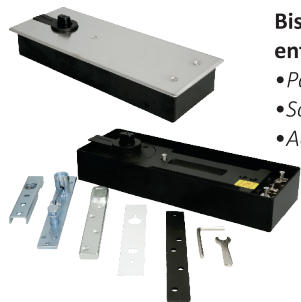

Bisagra hidráulica de piso entrada rectangular.

- Para: Puerta máx. 1 m.
- Soporta: 130 kg.
- Acabado: Satín.

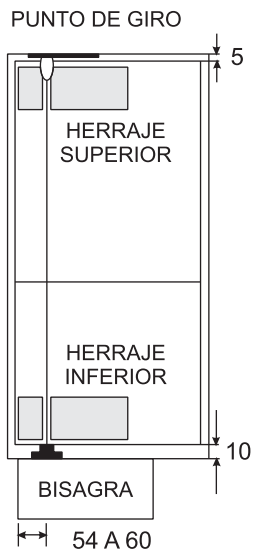
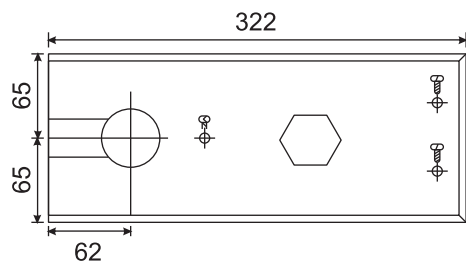

B200-B



Bisagra hidráulica de piso entrada rectangular.

- Para: Puerta máx. 1 m.
- Soporta: 80 kg.
- Acabado: Satín.

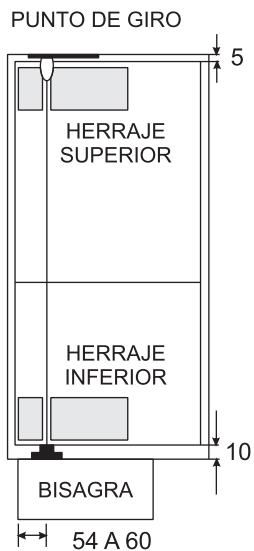
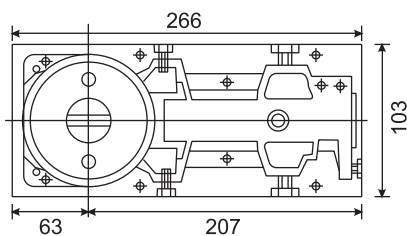

D030-B



Herraje superior para antepecho.

- Para: 8-12 mm.
- Material: Acero inox. 304.
- Acabado: Satín.

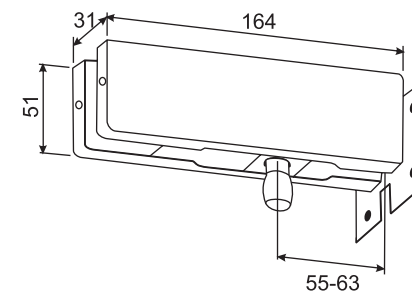

CORTE DE VIDRIO

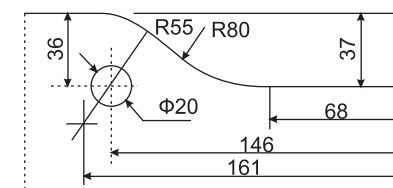

D040

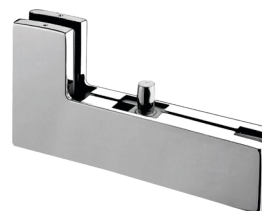

Herraje superior aleta.

- Para: 8-12 mm.
- Material: Acero inox. 304.
- Acabado: Satín.

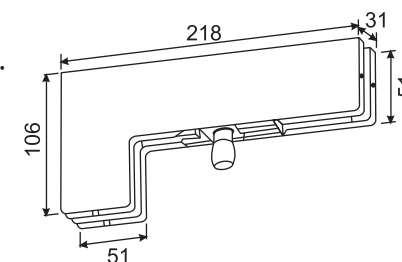

CORTE DE VIDRIO

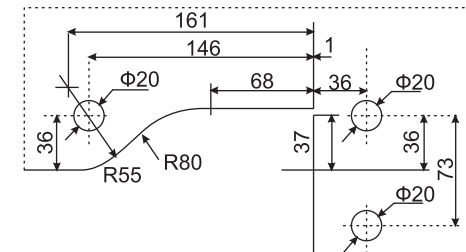

ZJ-020



Herraje superior.

- Para: 8-12 mm.
- Material: Acero inox. 304.
- Acabado: Satín.

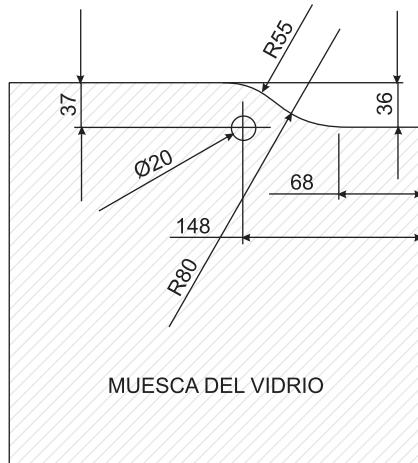
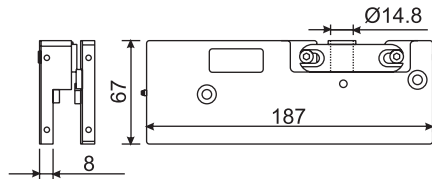

HP-L



Sistema hidráulico sin poso.

- Para: 8-12 mm.
- Puerta máx. 1 m.
- Soporta: 100 kg.
- Acabado: Satín
- No necesita bisagra hidráulica.

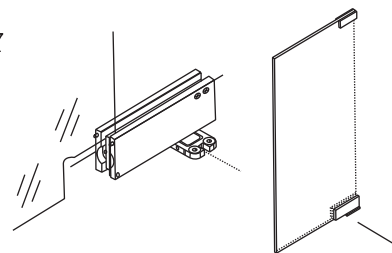
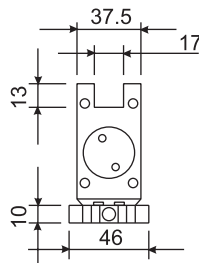
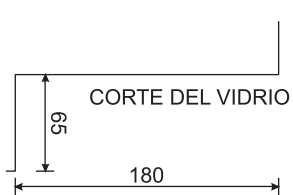
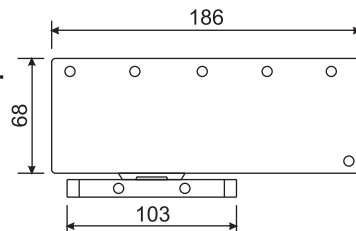

Medidas en mm.

XH091



Conector muro a tubo.

- Para: 3/4".
- Material: Zamac.
- Acabado: Satín.

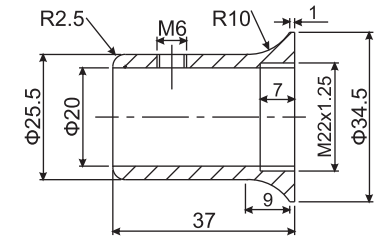

XH092



Conector ajustable vidrio a tubo.

- Para: 3/4".
- Material: Zamac.
- Acabado: Satín.

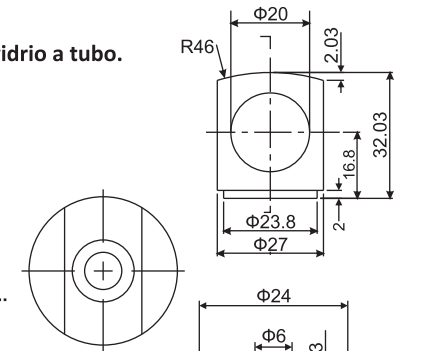

XH093



Conector ajustable vidrio a tubo.

- Para: 3/4".
- Material: Zamac.
- Acabado: Satín.

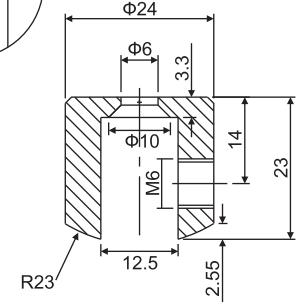

XH094



Conector ajustable tubo a tubo.

- Para: 3/4".
- Material: Zamac.
- Acabado: Satín.

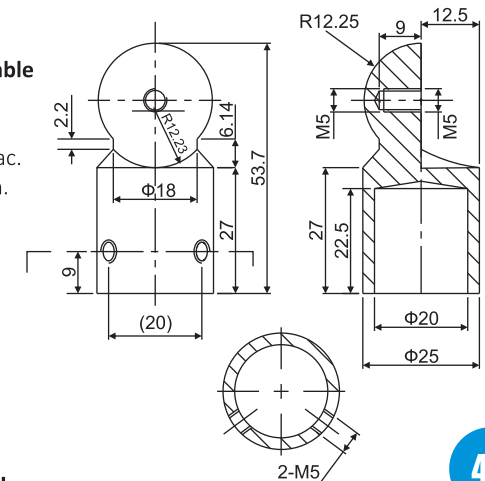

Medidas en mm.

XH095



Conector muro a tubo 45°.

- Para: 3/4".
- Material: Aluminio.
- Acabado: Satín.

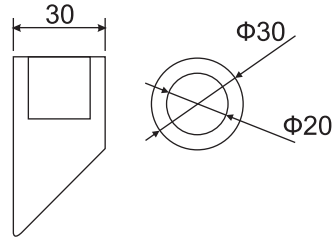

XH096



Conector tubo a tubo 90°.

- Para: 3/4".
- Material: Zamac.
- Acabado: Satín.

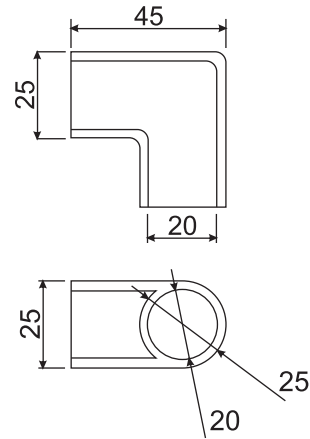

KH01-B



Sistema corredizo sin tubo.

- Para: 8-10 mm.
- Material: Acero inox. 304.
- Acabado: Negro mate.

KH02-B



Sistema corredizo sin tubo.

- Para: 10-12 mm.
- Material: Acero inox. 304.
- Acabado: Negro mate.

N0115-B



Escuadra para sistema corredizo.

- Material: Acero inox. 304.
- Acabado: Negro mate.

O2-B

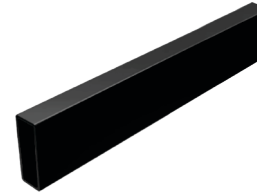

Tubo (riel) cuadrado para sistema corredizo

- Tamaño: 10 x 30 mm
- Largo: 2 m
- Calibre: 16
- Compatible: KH01-B
- Material: Acero inox. 304.
- Acabado: Negro mate.

XH-82801-B



Cerradura de puerta de cristal de mariposa.

- Para: 8-12 mm.
- Material: Acero inox. 304.
- Acabado: Negro mate.

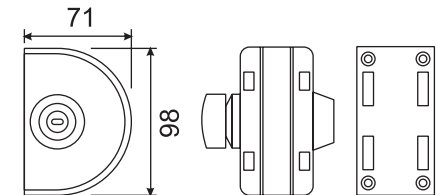

XH-82803-B



Cerradura de puerta de cristal doble de mariposa.

- Para: 8-12 mm.
- Material: Acero inox. 304.
- Acabado: Negro mate.

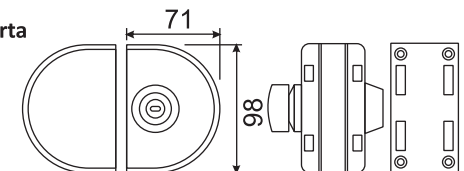

XH-83101-B



- Cerradura con mango.**
- Para: 8-12 mm.
 - Material: Acero inox. 304.
 - Acabado: Negro mate.

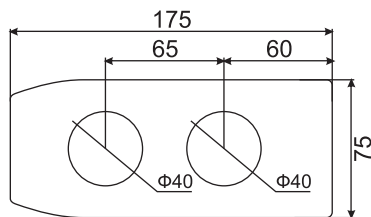

XH-83102P-B



- Contra para cerradura con mango.**
- Para: 8-12 mm.
 - Material: Acero inox. 304.
 - Acabado: Negro mate.

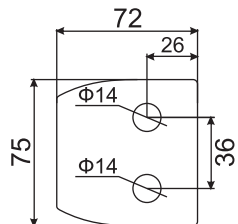

K-247-B



- Jaladera 30*30.**
- Material: Aluminio.
 - Acabado: Negro mate

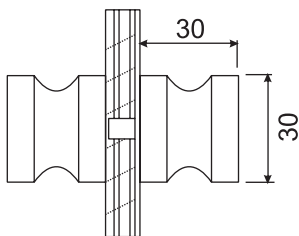

25*300-B



- Jaladera de 30.**
- Para: 8-12 mm.
 - Material: Acero inox. 304.
 - Acabado: Negro mate.

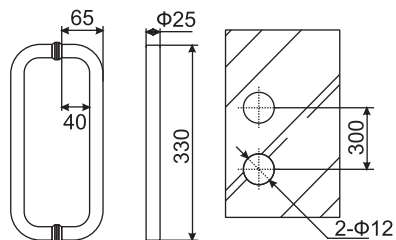

19*150-B



- Jaladera de 15.**
- Para: 8-12 mm.
 - Material: Acero inox. 304.
 - Acabado: Negro mate.

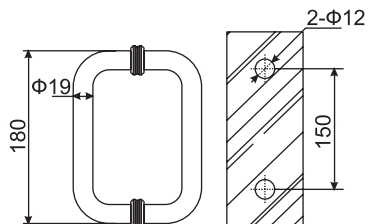

Medidas en mm.

SH-250-50-B • SH-250-90-B • SH-250-120-B • SH-250-150-B

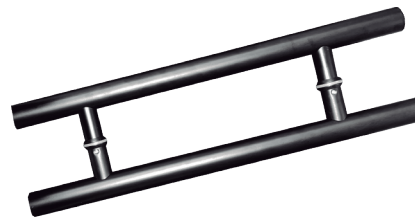

- Jaladera tipo H de 1-1/4.**
- Material: Acero inox. 304.
 - Acabado: Negro mate.
 - SH-250-50-B (50 cm) centros a 30 cm.
 - SH-250-90-B (90 cm) centros a 50 cm.
 - SH-250-120-B (120 cm) centros a 80 cm.
 - SH-250-150-B (150 cm) centros a 100 cm.



SH-530-20*45-B



- Jaladera toallero 20*45**
- Material: Acero inox. 304.
 - Acabado: Negro mate.

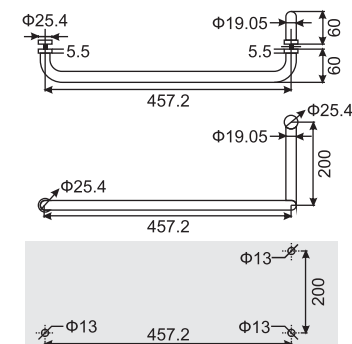

K-169-B



- Clip.**
- Para: 5-15 mm.
 - Soporta: 25 kg.
 - Material: Zamac.
 - Acabado: Negro mate.

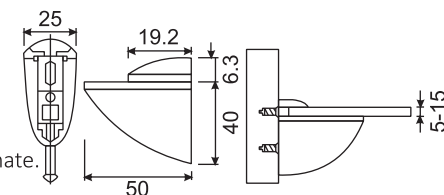

K-170-B



- Clip.**
- Para: 5-25 mm.
 - Soporta: 35 kg.
 - Material: Zamac.
 - Acabado: Negro mate.

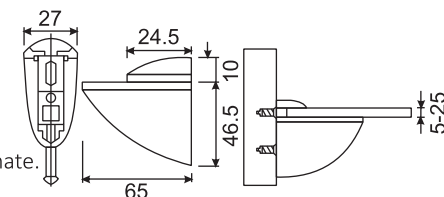

Medidas en mm.

K-512-B



Clip 180°.

- Para: 8-10 mm.
- Soporta: 50 kg.
- Material: Acero inox. 304.
- Acabado: Negro mate

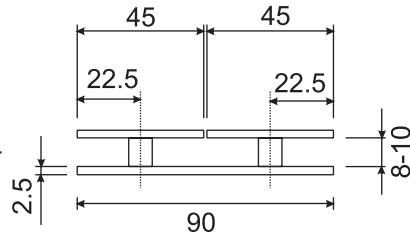

K-518-B



Clip.

- Para: 8-10 mm.
- Soporta: 50 kg.
- Material: Acero inox. 304.
- Acabado: Negro mate

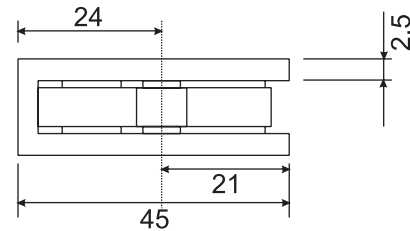

K-507-B



Clip 90°.

- Para: 8-10 mm.
- Soporta: 50 kg.
- Material: Acero inox. 304.
- Acabado: Negro mate.

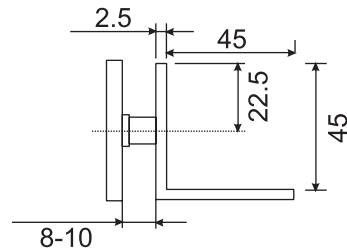

K-508-B



Clip 90°.

- Para: 8-10 mm.
- Soporta: 50 kg.
- Material: Acero inox. 304.
- Acabado: Negro mate.

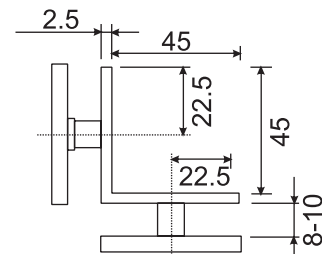

K-869Z-B



Clip de fijación ancho base curva.

- Para: 6-12 mm.
- Soporta: 30 kg.
- Material: Zamac.
- Acabado: Negro mate.

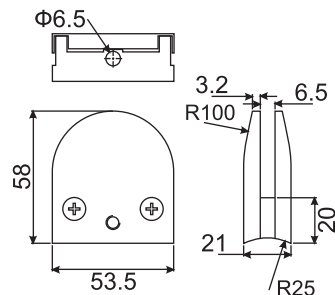

K-870Z-B



Clip de fijación ancho base plana.

- Para: 6-12 mm.
- Soporta: 30 kg.
- Material: Zamac.
- Acabado: Negro mate.

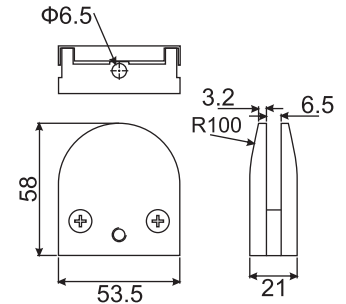

SH310-B



Bisagra muro a cristal desfasada.

- Para: 8-12 mm.
- Soporta: 25 kg.
- Material: Acero inox. 304.
- Acabado: Negro mate.

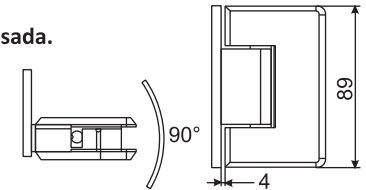

SH320-B



Bisagra muro a cristal centrada.

- Para: 8-12 mm.
- Soporta: 25 kg.
- Material: Acero inox. 304.
- Acabado: Negro mate.

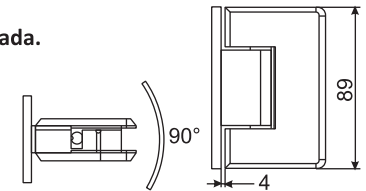

MODELOS SH310-B / SH320-B

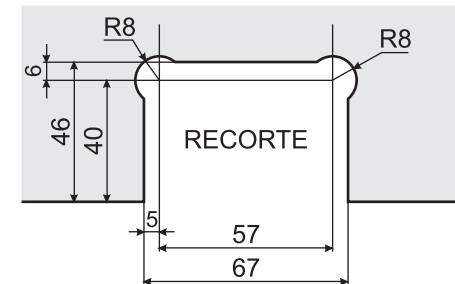

SH330-B



Bisagra cristal a cristal 180°.

- Para: 8-12 mm.
- Soporta: 25 kg.
- Material: Acero inox. 304.
- Acabado: Negro mate.

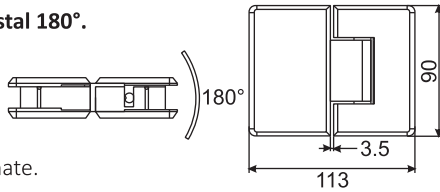

SH340-B



Bisagra cristal a cristal 135°.

- Para: 8-12 mm.
- Soporta: 25 kg.
- Material: Acero inox. 304.
- Acabado: Negro mate.

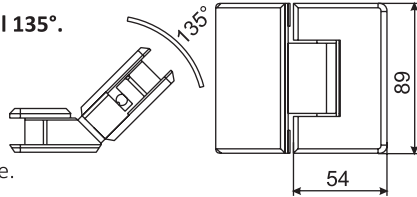

SH350-B



Bisagra cristal a cristal 90°.

- Para: 8-12 mm.
- Soporta: 25 kg.
- Material: Acero inox. 304.
- Acabado: Negro mate.

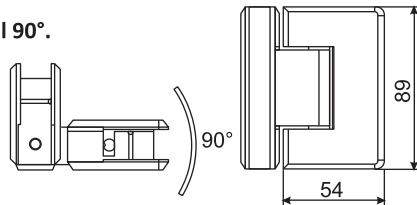

MODELOS SH330-B / SH340-B / SH350-B

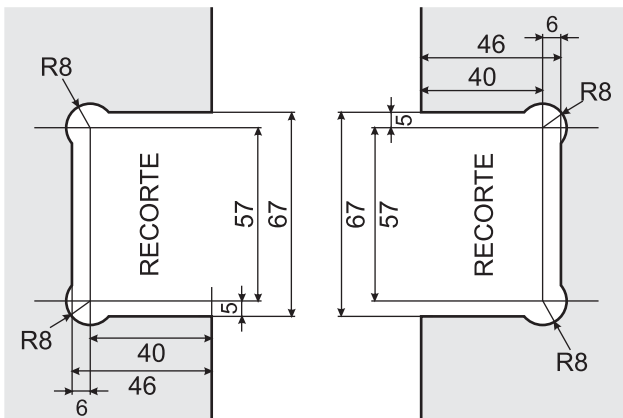

Medidas en mm.

SH300-B



Bisagra pivotante.

- Para: 8-12 mm.
- Soporta: 25 kg.
- Material: Acero inox. 304.
- Acabado: Negro mate

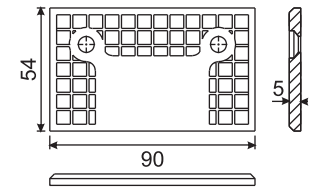

MODELO SH300-B

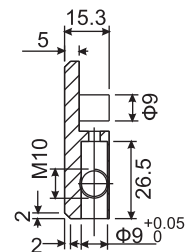
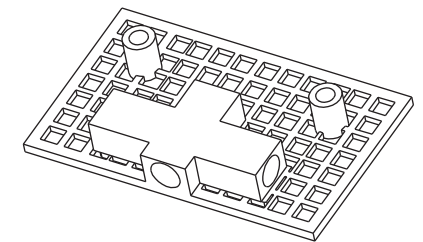
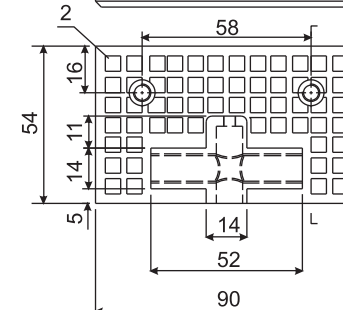
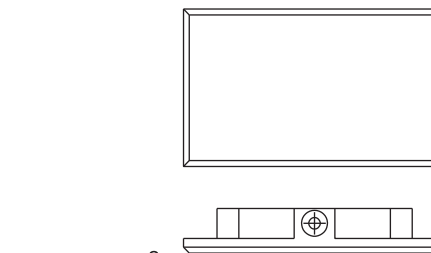
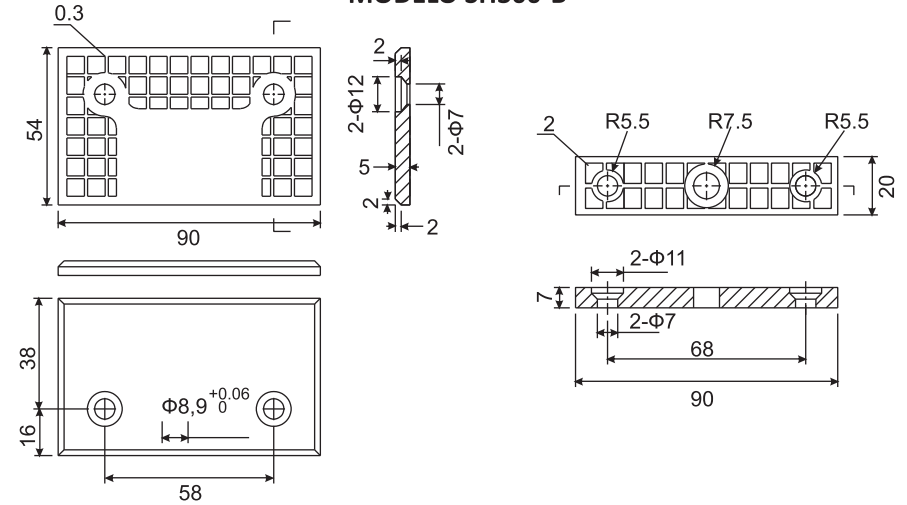

Medidas en mm.

C-003-B



SopORTE de fijación muro a vidrio con taquete.

- Para: 8-12 mm.
- Soporta: 30 kg.
- Material: Acero inox. 304.
- Acabado: Negro mate.

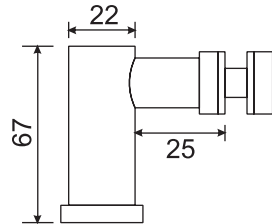

PH804-1-B



Conector muro a tubo.

- Soporta: 30 kg.
- Material: Acero inox. 304.
- Acabado: Negro mate.

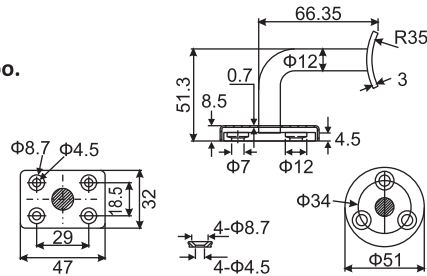

PH804-B



Conector vidrio a tubo.

- Para: 8-12 mm.
- Soporta: 30 kg.
- Material: Acero inox. 304.
- Acabado: Negro mate.

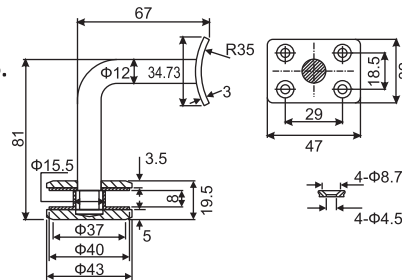

C011-B



Conector vidrio a vidrio.

- Material: Acero inox. 304.
- Acabado: Negro mate.

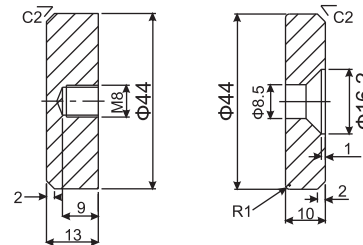

C012-L-B

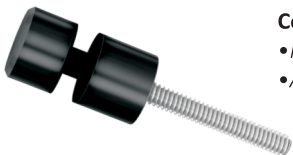

Conector muro a vidrio.

- Material: Acero inox. 304.
- Acabado: Negro mate.

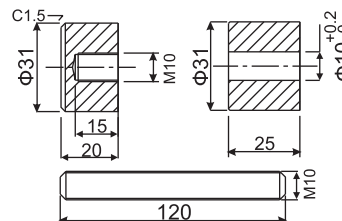

M100-B



Mini Poste.

- De: 25 cm.
- Para: 8-12 mm.
- Diámetro: 1 1/4".
- Material: Acero inox. 304.
- Acabado: Negro mate.

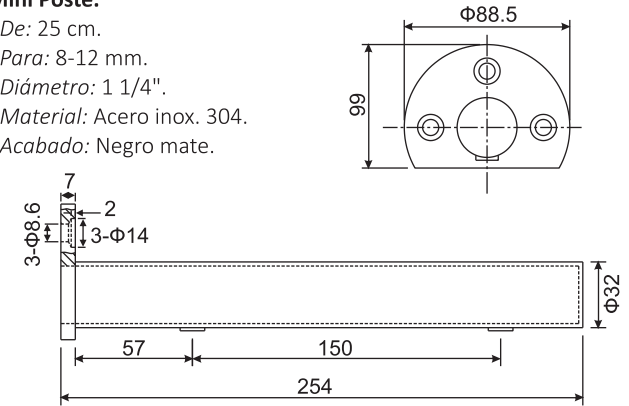

M155-B



Grapa rectangular.

- Para: 8-12 mm.
- Material: Acero inox. 304.
- Acabado: Negro mate.

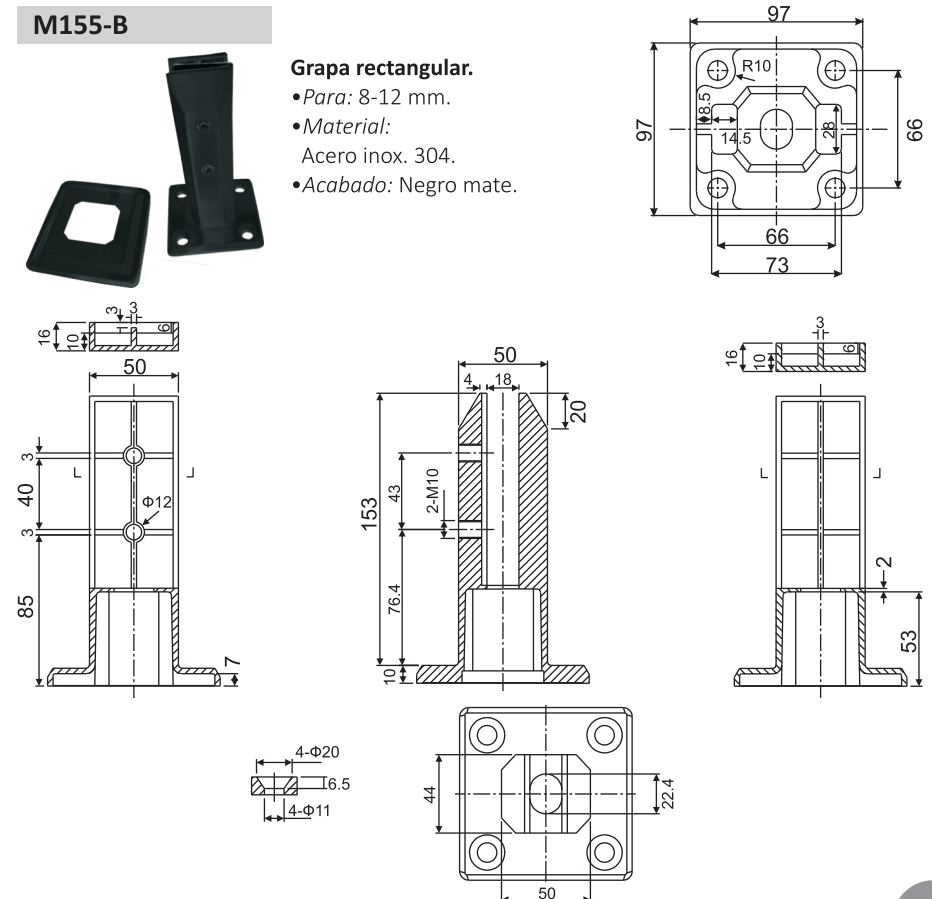

D-050-B



Cerradura de esquina

- Para: 8-12 mm.
- Material: Acero inox. 304.
- Acabado: Negro mate.

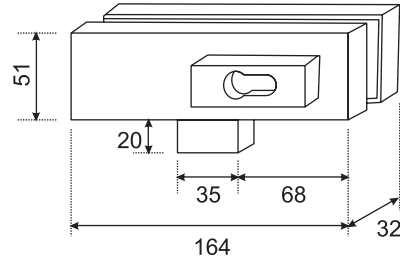

CORTE DE VIDRIO

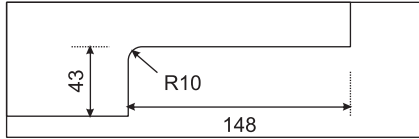

D-020-B



Herraje superior.

- Para: 8-12 mm.
- Material: Acero inox. 304.
- Acabado: Negro mate.

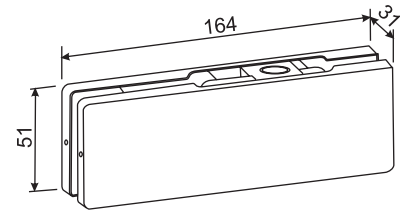

CORTE DE VIDRIO

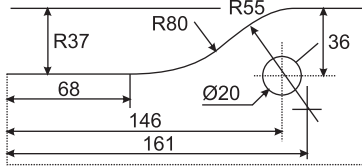

D-010-B



Herraje inferior.

- Para: 8-12 mm.
- Material: Acero inox. 304.
- Acabado: Negro mate.

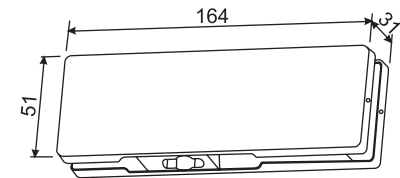

CORTE DE VIDRIO

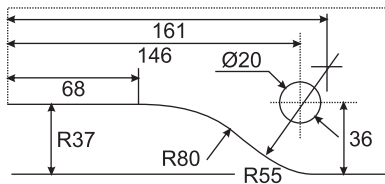

Medidas en mm.

CB-322-B



Tapa para bisagra hidráulica de piso entrada rectangular.

- Para: Puerta máx. 1 m.
- Soporta: 130 kg.
- Acabado: Negro Mate.

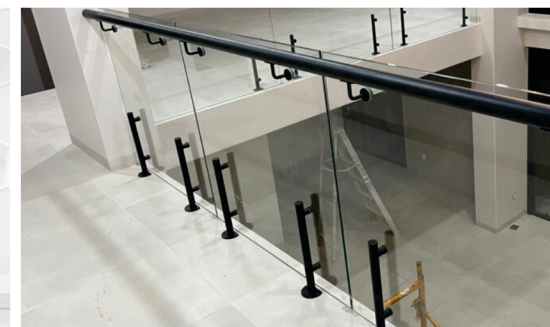
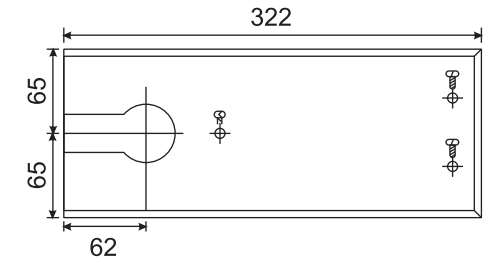

KH01-G



Sistema corredizo sin tubo.

- Para: 8-10 mm.
- Material: Acero inox. 304.
- Acabado: Oro.

N0115-G

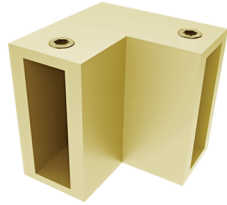

Escuadra para sistema corredizo.

- Material: Acero inox. 304
- Acabado: Oro.

O2-G

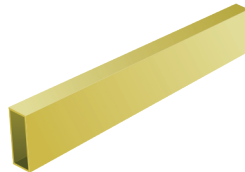

Tubo (riel) cuadrado para sistema corredizo

- Tamaño: 10 x 30 mm con un largo de 2m.
- Calibre: 16
- Compatible: KH01/KH01Z/KH01S
- Material: Acero inox. 304 con acabado oro.

K-247-G



Jaladera 30*30.

- Material: Aluminio.
- Acabado: Oro.

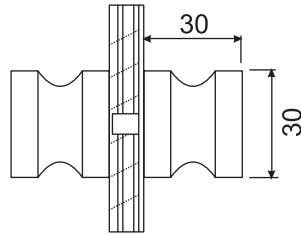

19*150-G



Jaladera de 15.

- Para: 8-12 mm.
- Material: Acero inox. 304.
- Acabado: Oro.

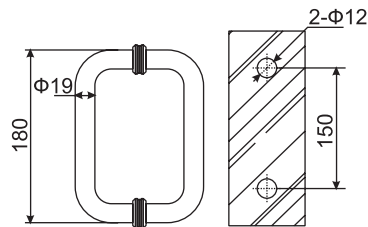

K-512-G

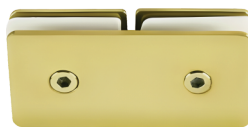

Clip 180°.

- Para: 8-10 mm.
- Soporta: 50 kg.
- Material: Acero inox. 304.
- Acabado: Oro.

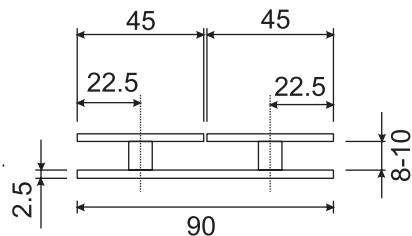

K-518-G

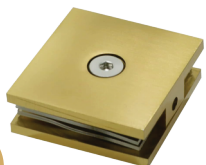

Clip.

- Para: 8-10 mm.
- Soporta: 50 kg.
- Material: Acero inox. 304.
- Acabado: Oro.

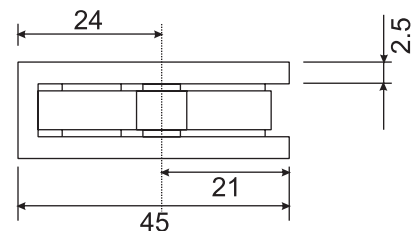

Medidas en mm.

K-507-G



Clip 90°.

- Para: 8-10 mm.
- Soporta: 50 kg.
- Material: Acero inox. 304.
- Acabado: Oro.

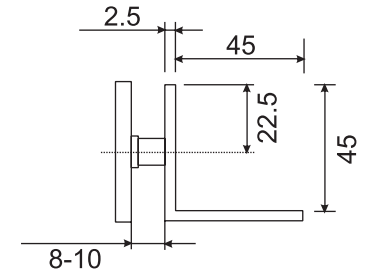

K-508-G



Clip 90°.

- Para: 8-10 mm.
- Soporta: 50 kg.
- Material: Acero inox. 304.
- Acabado: Oro.

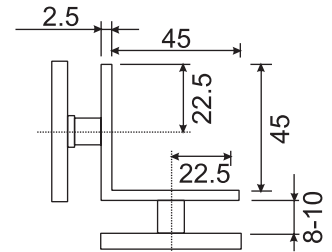

SH320-G



Bisagra muro a cristal centrada.

- Para: 8-12 mm.
- Soporta: 25 kg.
- Material: Acero inox. 304.
- Acabado: Oro.

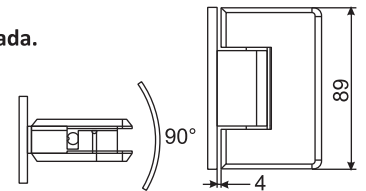

SH330-G

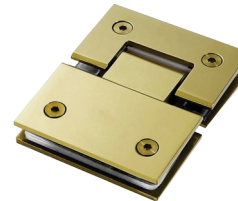

Bisagra cristal a cristal 180°.

- Para: 8-12 mm.
- Soporta: 25 kg.
- Material: Acero inox. 304.
- Acabado: Oro.

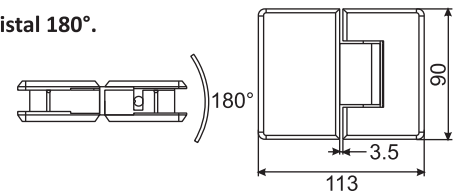

SH350-G



Bisagra cristal a cristal 90°.

- Para: 8-12 mm.
- Soporta: 25 kg.
- Material: Acero inox. 304.
- Acabado: Oro.

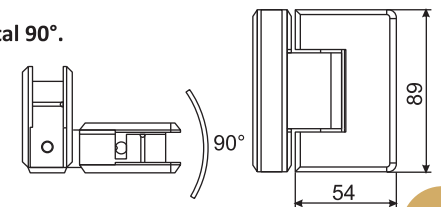

Medidas en mm.

WR01



Carretilla tandem para línea europea, rodajas de nylon para 3".

- Para: máx. 80 kg.
- Material: Acero al carbón.
- Acabado: Pintura electrostática.

WR02



Carretilla para línea europea, balero nylon para 3".

- Para: máx. 50 kg.
- Material: Lámina de acero al carbón cal. 14.
- Acabado: Pintura electrostática.

WR09



Carretilla balero nylon para ventana y puerta corrediza 2".

- Para: máx. 25 kg.
- Material: Lámina de acero al carbón.
- Acabado: Pintura electrostática.

WR03



Carretilla para ventana corrediza, balero de nylon para 2".

- Para: máx. 10 kg.
- Material: Lámina de acero al carbón cal. 14.
- Acabado: Pintura electrostática.

WR04



Carretilla tipo europea, rodaja nylon para ventana y puerta corrediza 2".

- Para: máx. 25 kg.
- Material: Lámina de acero cal. 20.
- Acabado: Pintura electrostática.

WR05

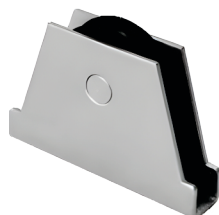

Carretilla tipo europea para mosquitero, balero nylon 2".

- Para: máx. 12 kg.
- Material: Lámina de acero cal. 18.
- Acabado: Galvanizado.

WR20



Carretilla cola de ratón para mosquitero, rodaja nylon.

- Para: máx. 15 kg.
- Material: Lámina de acero templado.
- Acabado: Galvanizado.

WR06



Carretilla, balero nylon 2".

- Para: máx. 10 kg.
- Material: Acero al carbón.
- Acabado: Pintura electrostática.

WR10



Carretilla ensamble rápido, balero nylon 3".

- Para: máx. 30 kg.
- Material: Nylon.
- Acabado: Blanco.

WR12



Carretilla tandem ajustable, doble balero de nylon 1 1/4 para 3".

- Para: máx. 50 kg.
- Material: Acero al carbón.
- Acabado: Tropicalizado.

WR7



Carretilla con balero de nylon.

- Para: máx. 50 kg.
- Material: Acero al carbón.
- Acabado: Tropicalizado.

WR8



Carretilla con doble balero de nylon.

- Para: máx. 50 kg.
- Material: Acero al carbón.
- Acabado: Tropicalizado.

WR11

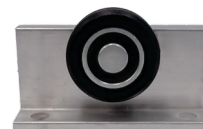

Carretilla española para baño baja.

- Para: máx. 25 kg.
- Material: Aluminio.
- Acabado: Galvanizado.

WR13

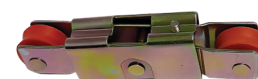

Carretilla con doble rodaja de nylon para ventana doble.

- Para: máx. 50 kg.
- Material: Acero al carbón.
- Acabado: Tropicalizado.

WR15



Carretilla con rodaja de nylon.

- Para: máx. 50 kg.
- Material: Nylon.
- Acabado: Pintura electrostática.

WR16

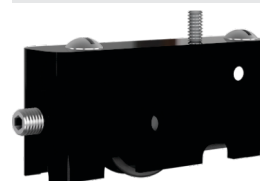

Carretilla con balero de nylon e interior ajustable.

- Para: máx. 50 kg.
- Material: Aluminio.
- Acabado: Pintura electrostática.

WR17

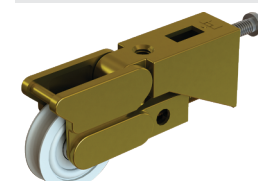

Carretilla ajustable con balero de nylon.

- Para: máx. 25 kg.
- Material: Zamac.
- Acabado: Tropicalizado.

DL001

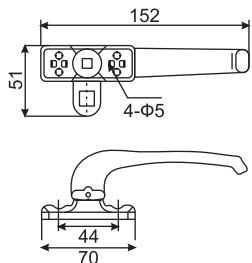

Jaladera reversible para
venta de proyección tipo europea.

- Para: Ventana.
- Material: Aluminio.
- Acabado: DL001-W Blanco
DL001-B Negro
DL001-G Gris.



DS01



Tope media luna.

- Material: Acero inox. 304.
- Acabado: Satín.

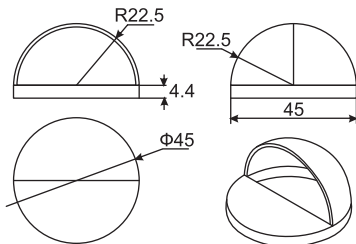

DS02



Tope chico.

- Material: Acero inox. 304.
- Acabado: Satín.

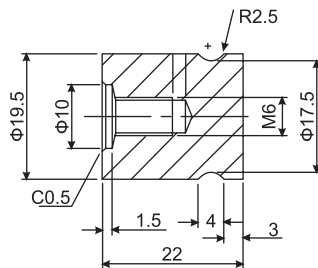

DS03



Tope grande.

- Material: Acero inox. 304.
- Acabado: Satín.

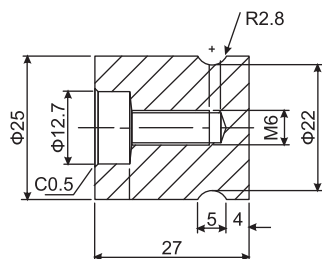

Medidas en mm.

DL002



Chapa
doble manija,
tipo europea,
llaves de alta
seguridad,
tapas y
porta cilindros,
manijas separadas.

- Para: Línea aluminio.
- Material: Cuerpo de acero, chapetón y contra de acero inox.
- Acabado: DL002-W Blanco.
DL002-B Negro.
DL002-G Gris.

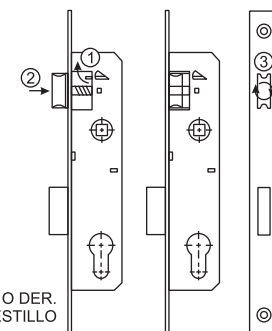
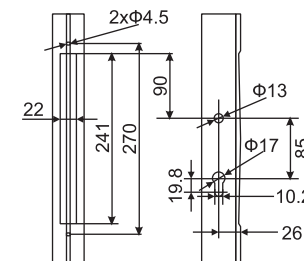

FÁCIL CAMBIO DE LADO IZQ. O DER.
PRESIONE Y GIRE EL PESTILLO

DL003



Chapa de gancho.

- Para: Línea de 3".
- Material: Cuerpo de lámina y tapas de acero inox.
- Acabado: DL003-W Blanco.
DL003-B Negro.
DL003-G Gris.

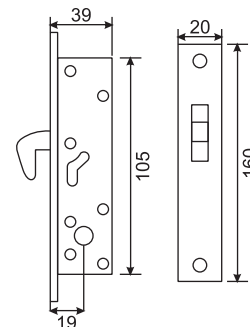

Medidas en mm.

DL004



MODELOS DL004 / DL005

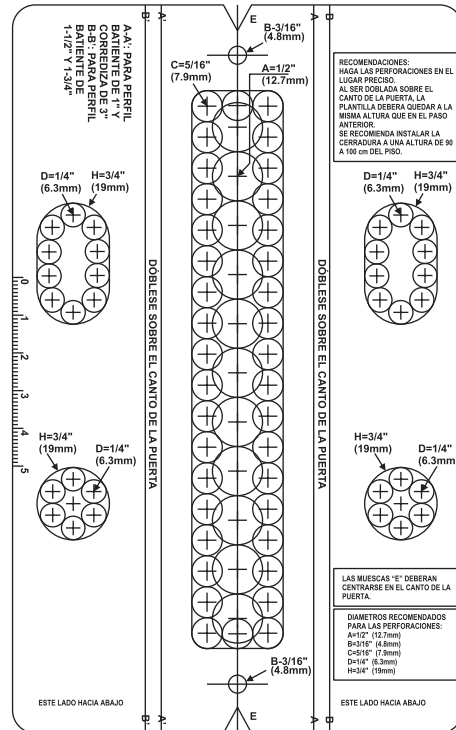

ESCALA AL 50%

Chapa llave-llave con manija.

- **Material:** Cuerpo de acero y tapas de aluminio.

DL005



Chapa llave-mariposa con manija.

- **Material:** Cuerpo de acero y tapas de aluminio.
- **Acabado:** DL005-W Blanco, DL005-B Negro, DL005-G Gris.

Medidas en mm.

WL001



Jaladera de embutir.

- **Para:** Línea nacional de 2".
- **Material:** Aluminio.
- **Acabado:** WL001-W Blanco, WL001-B Negro, WL001-G Gris.

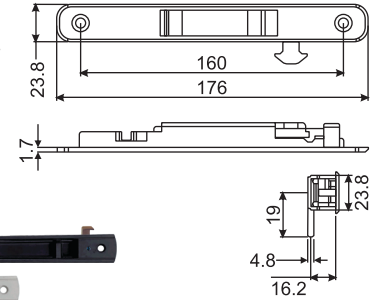

WL002



Jaladera de embutir.

- **Para:** Línea nacional de 3".
- **Material:** Aluminio.
- **Acabado:** WL002-W Blanco, WL002-B Negro, WL002-G Gris.

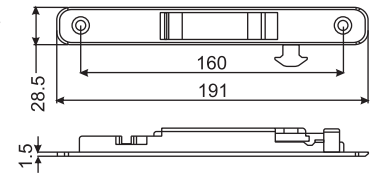

WL003



Jaladera de embutir.

- **Para:** Línea europea de 2".
- **Material:** Aluminio.
- **Acabado:** WL003-W Blanco, WL003-B Negro, WL003-G Gris.

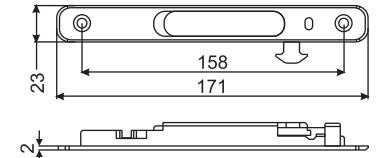

WL004



Jaladera de embutir.

- **Para:** Línea europea de 3".
- **Material:** Aluminio.
- **Acabado:** WL004-W Blanco, WL004-B Negro, WL004-G Gris.

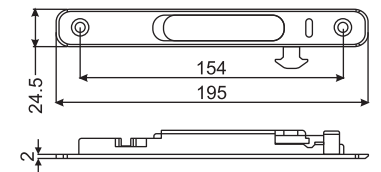

Medidas en mm.

WR14

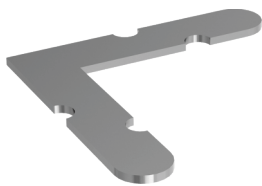

Escuadra para elaborar marcos mosquiteros

- De: 9.14 mm.
- Material: Lámina de aluminio cal. 14.
- Acabado: Satín.
- Venta múltiplos de 100.

HN01



Bisagra para puertas y ventanas 3 palas

- Soporta: 90 kg x par.
- Material: Aluminio.
- Acabado: HN01-B Negro.
HN01-W Blanco.
HN01-G Gris.

HN02



Bisagra para puertas y ventanas 2 palas

- Soporta: 50 kg x par.
- Material: Aluminio.
- Acabado: HN02-B Negro.
HN02-W Blanco.
HN02-G Gris.

WS18-8-2

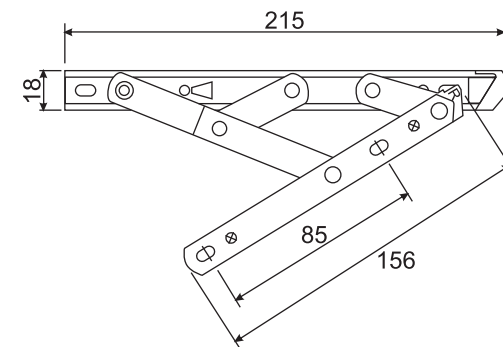

Brazo de proyección

- De: 8 mm.
- Material: Acero inox. 304.
- Acabado: Satín.

HN03



Bisagra para puerta y ventana

- Soporta: 50 kg x par.
- Material: Aluminio.
- Acabado: HN03-B Negro.
HN03-W Blanco.
HN03-G Gris.

HN04



Bisagra para ventana y ventana

- Soporta: 25 kg x par.
- Material: Aluminio.
- Acabado: HN04-B Negro.
HN04-W Blanco.
HN04-G Gris.

HN05



Bisagras tipo libro 3x3"

- Material: Aluminio.
- Acabado: HN05-B Negro.
HN05-W Blanco.
HN05-G Satín.

WR19-12-2



Brazo de proyección

- De: 12 mm.
- Material: Acero inox. 304.
- Acabado: Satín.

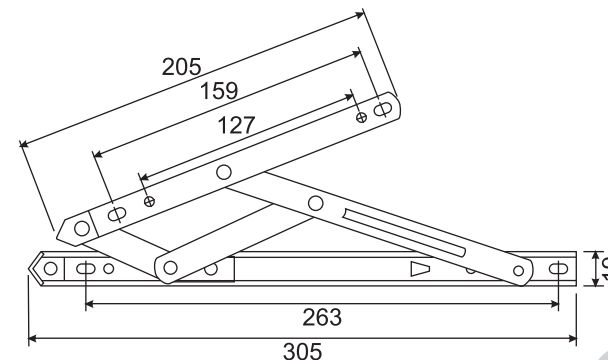

HA01



Tirador

- Material: Aluminio.
- Acabado: HA01-B Negro.
HA01-W Blanco.
HA01-G Gris.

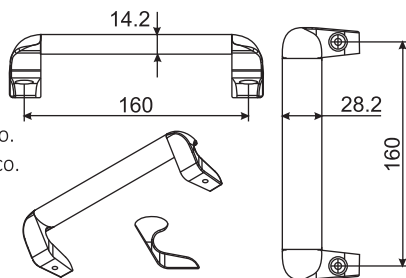

Medidas en mm.

Cerradores, sistemas corredizos
cerraduras y chapas

XH-073	3
XH-072	3
XH-071	3
KH01	4
KH01-Z	4
KH01Z-S	4
KH01-S	4
KH02	4
KH03	4
B023	4
N0115	4
N0115-C	4
N0208	5
O15-S	5
O2-C	5
O2-S	5
AL03	5
XH-82801	8
XH-82802	8
XH-82803	8
XH-82804	8
XH-82805	8
XH-82806	9
XH-83101	10
XH-83102P	10
XH-83301	10

Cerradores, sistemas corredizos
cerraduras y chapas

XH-83302	10
XH-84201	10
XH-84202	11
XH-84801	11
XH-84802P	12
J101	12
J102	12

Jaladeras, clips,
bisagras y separadores

K-246-C	13
K-246-S	13
K-247-C	13
K-247-S	13
K-264-C	13
25*300-C	13
25*300-SN	13
19*150-C	14
19*150-SN	14
SH-250-50	14
SH-250-90	14
SH-250-120	14
SH-250-150	14
SH-530-20*45	14
SH260	15
SH-250-K-120	15
SH-250-K-150	15
K-121-12-C	16
K-121-12-S	16
K-128-12-C	16
K-128-12-S	16
K-239-L	16
K-169-C	16
K-169-S	16
K-170-C	16
K-170-S	16
K-170-1-C	17
K-170-1-S	17
K-826	17

Jaladeras, clips,
bisagras y separadores

K-827	17
K-163	17
K-163-1	17
K-165	18
K-166	18
K-822	18
K-823	18
K-824	18
K-510-C	18
K-510	18
K-512-C	19
K-512	19
K-513	19
K-518-C	19
K-518	19
K-507-C	19
K-507	19
K-508-C	19
K-508	19
K-858-C	20
K-858-S	20
K-861-C	20
K-861-S	20
K-862-C	20
K-862-S	20
K-844	20
K-846	20

Jaladeras, clips,
bisagras y separadores

K-174-10	21
K-946	21
K-947	21
ZL6214-C	21
ZL6214-SN	21
ZL6215-C	21
ZL6215-SN	21
Z6216-C	22
Z6216-SN	22
Z6217-C	22
Z6217-SN	22
Z6218-C	22
Z6218-SN	22
SH310-C	23
SH310-S	23
SH320-C	23
SH320-S	23
SH330-C	24
SH330-S	24
SH340-C	24
SH340-S	24
SH350-C	24
SH350-S	24
SH300-C	25
SH300-S	25
K-258-1	26

Soportes, conectores y
complementos

C-005	27
C-003	27
C-001	27
K-957-25	27
K-957-32	28
K-961-25	28
K-961-32	28
M063	29
M063-L	29
M063-R	29
PH800-1-SN	30
PH804-1-SN	30
PH800-SN	30
PH804-SN	30
C011	30
ALC011	31
M112	31
M312	31
M309	31
M109	32
M101	32
M301	32
C012	32
TC012	32
C012-L	33
C013	33
C014	33
M126	33
M125H	33
M125	34
M325	34

Soportes, conectores y
complementos

M075	34
PH001-SN	34
PH002-SN	34
M090	35
PH003-SN	35
PH005-SN	35
K-869-C	35
K-869-S	35
K-870-C	35
K-870-S	35
K-869Z-S	36
K-870Z-S	36
P-871	36
P-872	36
F001	37
F002	37
F004	37
F005	37
C101	38
C102	38
C103	38
C104	38
C105	39
M100	40
M100-L	40
M155	41
M156	42
HN06	42

Herrajes para acceso

A-607	43
D-050	43
D-020	44
D-010	44
B-322	45
B200-B	45
D030-B	46
D040	46
ZJ-020	47
HP-L	47

Línea para barra estabilizadora

XH091	48
XH092	48
XH093	48
XH094	48
XH095	49
XH096	49

Línea black

KH01-B	50
KH02-B	50
N0115-B	50
O2-B	50
XH-82801-B	50
XH-82803-B	50
XH-83101-B	51
XH-83102P-B	51
K-247-B	51
25*300-B	51
19*150-B	51
SH-250-50-B	52
SH-250-90-B	52
SH-250-120-B	52
SH-250-150-B	52
SH-530-20*45-B	52
K-169-B	52
K-170-B	52
K-512-B	53
K-518-B	53
K-507-B	53
K-508-B	53
K-869Z-B	53
K-870Z-B	54
SH310-B	54
SH320-B	54
SH330-B	55
SH340-B	55
SH350-B	55
SH300-B	56
C-003-B	57
PH804-1-B	57
PH804-B	57
C011-B	57
C012-L-B	57

Línea black

M100-B	58
M155-B	58
D-050-B	59
D-020-B	59
D-010-B	59
CB-322-B	60

Línea Gold

KH01-G	61
N0115-G	61
O2-G	61
K-247-G	61
19*150-G	61
K-512-G	61
K-518-G	61
K-507-G	62
K-508-G	62
SH320-G	62
SH330-G	62
SH-350-G	62

Línea Aluminio

WR01	63
WR02	63
WR09	63
WR03	63
WR04	63
WR05	63
WR20	63
WR06	63
WR10	63
WR12	64
WR7	64
WR8	64
WR11	64
WR13	64
WR15	64
WR16	64
WR17	64
DL001	65
DS01	65
DS02	65
DS03	65
DL002	66
DL003	66

Línea Aluminio

DL004	67
DL005	67
WL001	68
WL002	68
WL003	68
WL004	68
WR14	69
HN01	69
HN02	69
HN03	69
HN04	69
HN05	69
HA01	69
WS18-8-2	70
WR19-12-2	70

