

Serie 7700 7700 Series

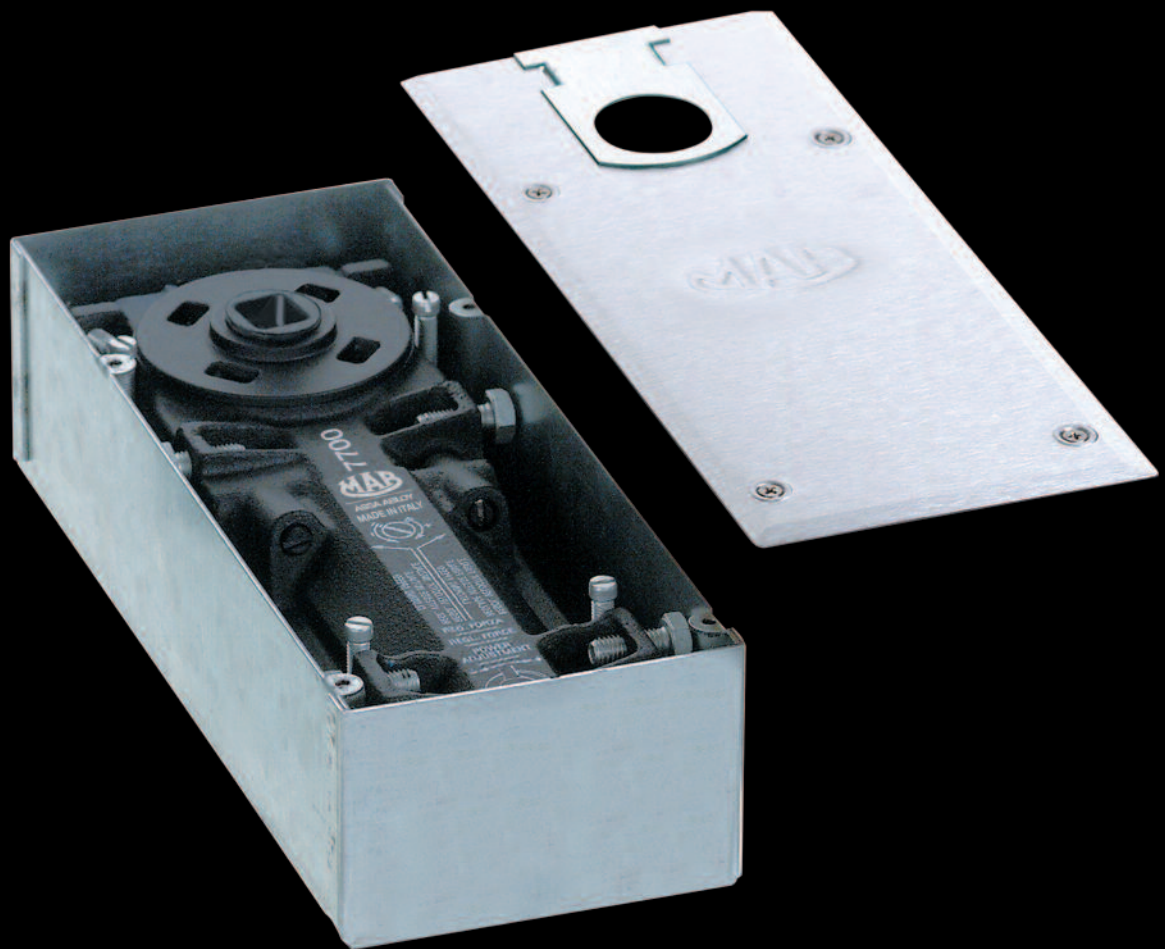

ASSA ABLOY, the global leader
in door opening solutions



Chiudiporta a pavimento a potenza regolabile con freno meccanico

Adjustable power floor spring with mechanical back check

Caratteristiche tecniche:

- Forza regolabile in continuo EN 2-4 che unita ad alta efficienza permette una vera personalizzazione delle forze di apertura e chiusura.
- Universale per porte destre, sinistre e a ventola.
- Adatto per porte in legno, metallo, vetro.
- Ideale per interni residenziali grazie alla regolazione della potenza di apertura/chiusura che può rendere particolarmente dolce l'aprire una porta ed efficace il chiuderla.
- Ampia regolazione in tutti i sensi nella cassetta a murare per recuperare eventuali disallineamenti o dislivelli senza smontare la porta.
- Apertura consentita fino a 180° nei due sensi e richiamo idraulico da circa 150°, con fermaporta a 90°, 105° o in ogni angolo tra 150° e 180°. La versione senza fermo non permette l'apertura oltre 150° e chiude sempre.
- Velocità di chiusura controllata da due valvole indipendenti termostatiche di facile regolazione: chiusura dolce o con potente scatto finale per assicurare il tipo di chiusura più adatto.
- Valvola di sovrappressione atta a salvaguardare gli organi meccanici in caso di abusi.
- Freno meccanico all'apertura per smorzare aperture incontrollate.
- Varietà di perni disponibili: italiano (standard), tedesco, francese.
- Perno intercambiabile da 0 a + 30 mm.
- Ampia gamma di finiture della piastra di copertura: inox lucido, inox satinato, ottone lucido.

Specifiche per capitoli

Chiudiporta a pavimento a potenza regolabile con freno meccanico all'apertura, MAB 7700 (EN 2-4).

Features:

- *Adjustable power EN 2-4 by means of stepless governor which coupled with high efficiency allows a real personalization of opening/closing forces.*
- *Universal for right, left or double action doors.*
- *Suitable for timber, metal and glass doors.*
- *Ideal for residential interiors thanks to adjustable opening/closing force that makes door opening/closing easy.*
- *Large range of adjustment within cement box to solve possible alignment problems on site without taking down the door.*
- *Opening up to 180° in both swings with hydraulic control from approx 150°, hold open at 90°, 105° or any angle between 150° and 180°. The non hold open version has a back stop at 150°.*
- *Closing speed controlled by two easily adjustable independent thermostatic valves: soft closing or powerful latching action to ensure proper closing also in case of hard-to-latch locks.*
- *Over pressure valve to safeguard the mechanical components in case of abuse.*
- *Mechanical back check to prevent uncontrolled openings.*
- *Variety of available spindles: square Italian (standard), square French, rectangular German, spindles.*
- *Interchangeable spindle from 0 to + 30 mm.*
- *Architectural finishes: coverplates in polished stainless steel, satin stainless steel, polished brass.*

Specifications

Adjustable power floor spring with mechanical back check, MAB 7700 (EN 2-4).

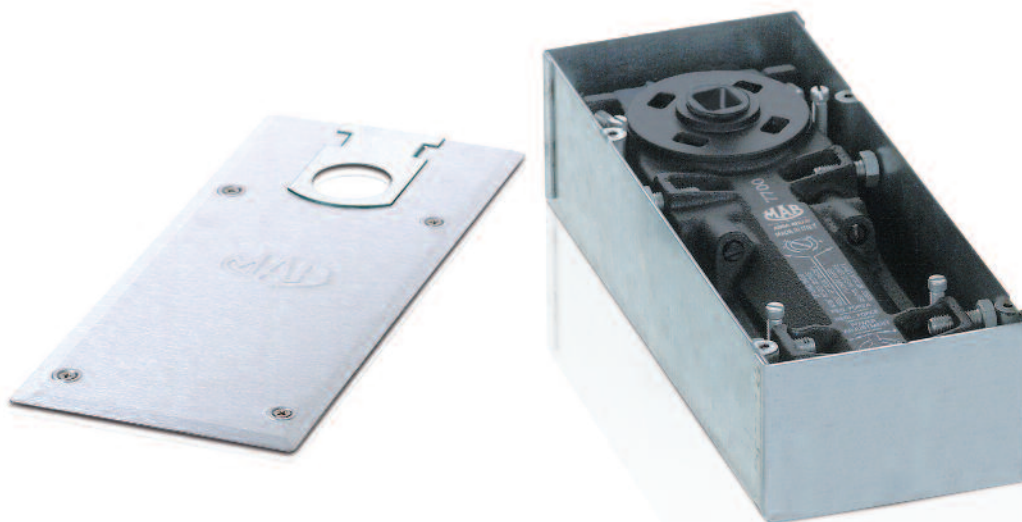

Regolazione nella cassetta a murare:
 - angolare 4°.
 - frontale 10 mm.
 - verticale 9 mm.

Adjustment within cement box:
 - angular 4°.
 - front 10 mm.
 - vertical 9 mm.

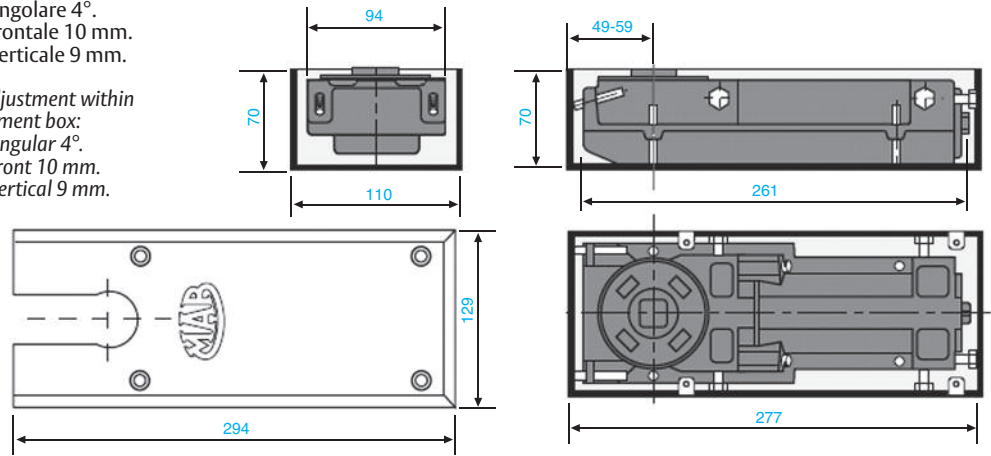

Piastre di copertura
 da ordinare separatamente
*Coverplates
 to be ordered separately*



Colori / Colours

Ottone lucido / Polished brass

Acciaio satinato / Satin stainless steel

Acciaio lucido / Polished stainless steel

Composizione del codice
Composition of article reference

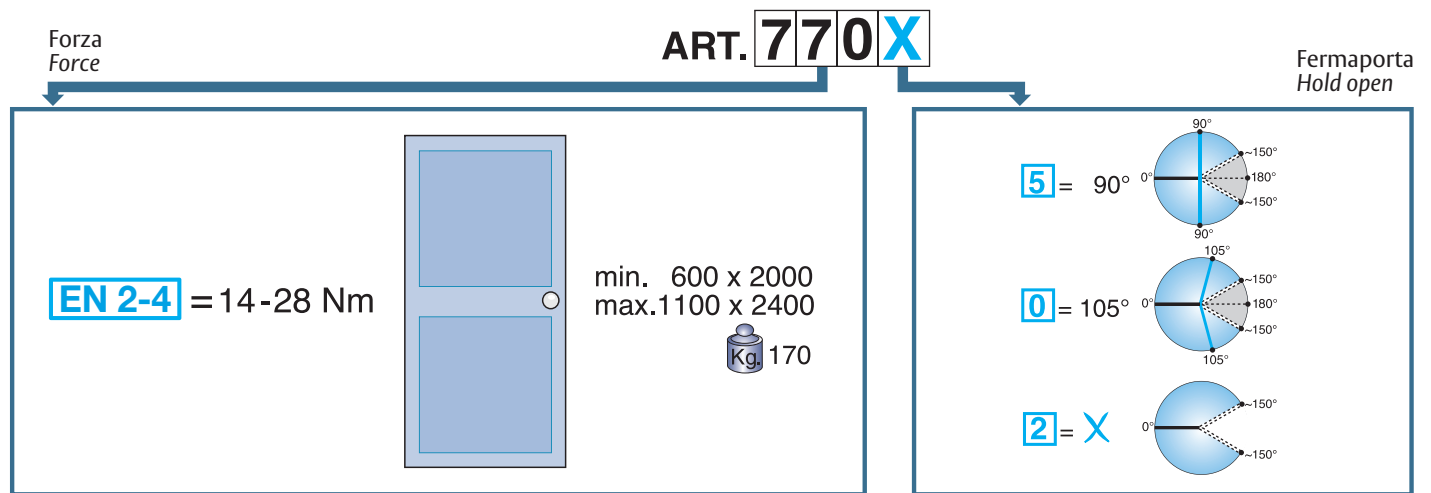

Identificazione del fermo
Hold open identification

Data di produzione
 MM-AA (mese - anno)

Date of manufacture
 MM-YY (month - year)

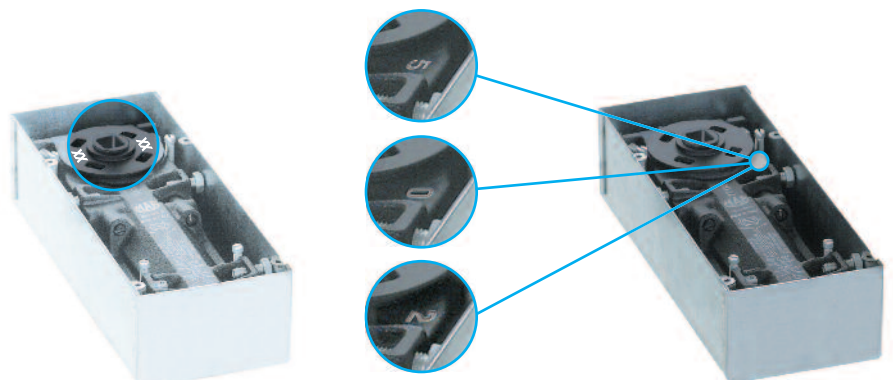

Controllo di chiusura

Closing control

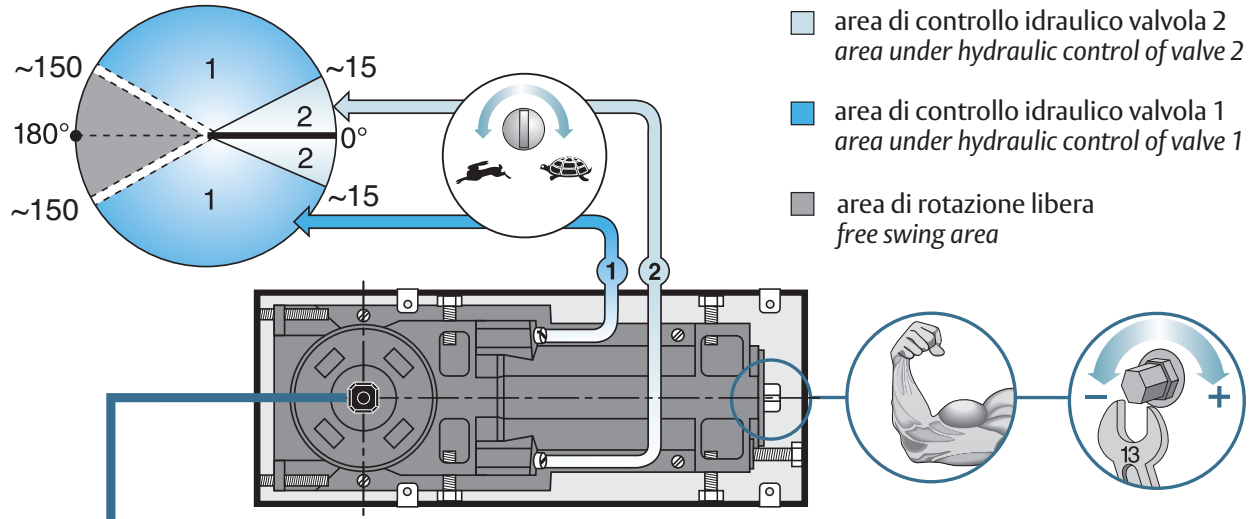

L'uso di un olio estremamente termostabile rende rara l'utilizzazione delle valvole.
 Valvola 1: regola la velocità di chiusura da 150° a 15°.
 Valvola 2: regola la velocità di chiusura da 15° a 0° (scatto finale).
The use of a highly thermoconstant hydraulic fluid makes speed adjustments rarely needed.
Valve 1 controls the closing speed from 150° to 15°.
Valve 2 controls the closing speed from 15° to 0° (final latch).

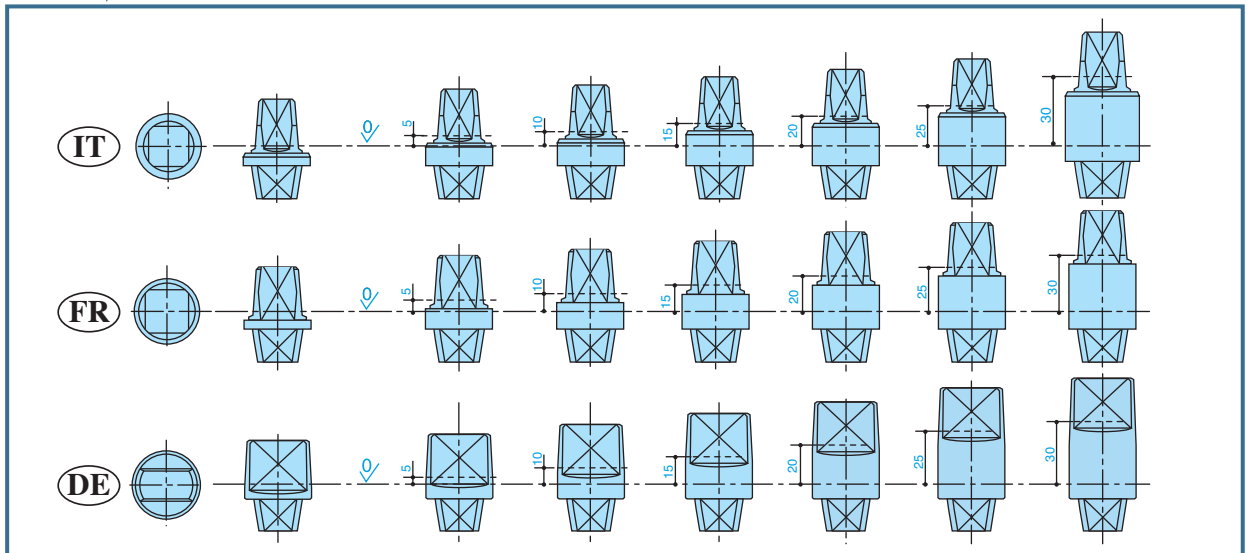

Montaggio universale

Universal mounting

Destra / Right

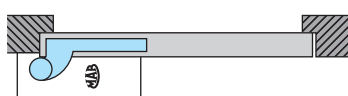

A ventola / Double action

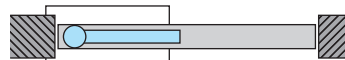

Sinistra / Left

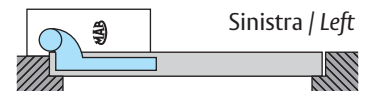

Codice / Code

AC 299

Piletta a murare perno rettangolare tedesco.
Floor idle pivot.
Rectangular German spindle.

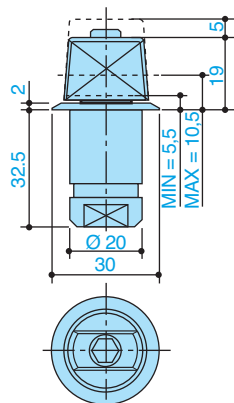

max. 120

Codice / Code

AC 298

Braccio inferiore in acciaio per porte a ventola.
Cava rettangolare tedesca.
Bottom arm in steel for double action doors.
Rectangular German spindle.

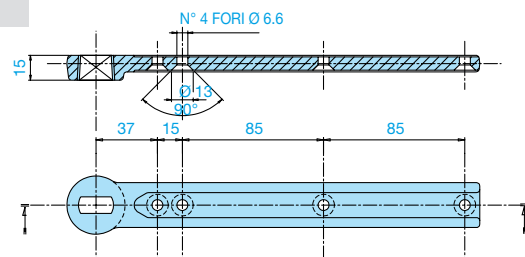

max. 300

Codice / Code

AC 246

Piletta a murare perno quadro italiano.
Floor idle pivot.
Square Italian spindle.

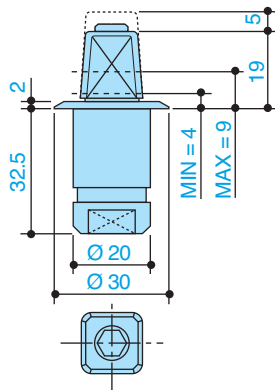

max. 120

Codice / Code

AC 297

Braccio inferiore in acciaio per porte a ventola.
Cava quadro italiano.
Bottom arm in steel for double action doors.
Square Italian spindle.

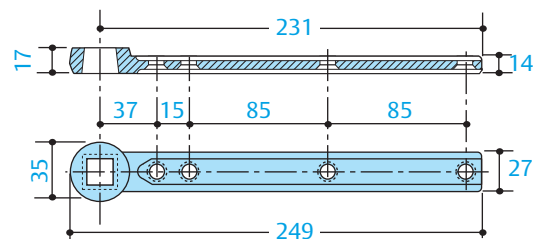

max. 300

Codice / Code

AC 213

Braccio inferiore in acciaio. Cava quadro italiano.
Bottom arm in steel for double action doors.
Square Italian spindle.

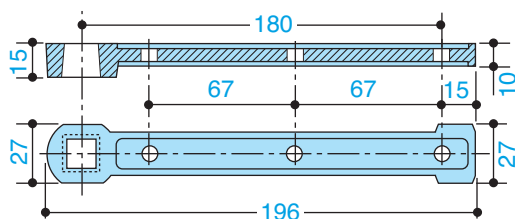

max. 170

Codice / Code

AC 2

Braccio inferiore in ottone per porte a ventola.
Cava quadro italiano.
Bottom arm in brass for double action doors.
Square Italian spindle.

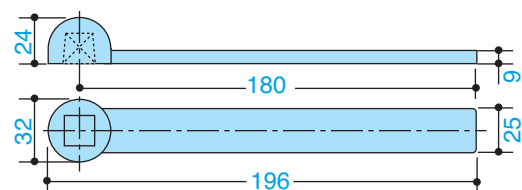

max. 100

Codice / Code

AC 115

Braccio inferiore reversibile in acciaio per porte a ventola. Cava quadro italiano.
Reversible bottom arm in steel for double action doors.
Square Italian spindle

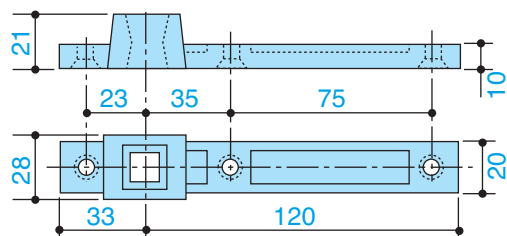

max. 300

Codice / Code

AC 393

Braccio inferiore reversibile in acciaio per porte a ventola. Cava rettangolare tedesca.
Reversible bottom arm in steel for double action doors.
Rectangular German spindle.

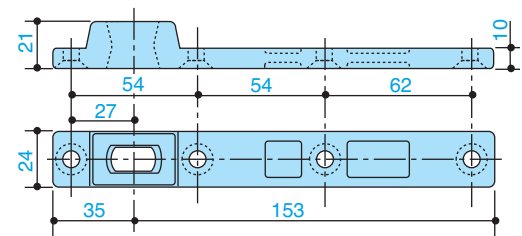

max. 300

Codice / Code

Braccio inferiore in acciaio. Cava quadro francese.
Bottom arm in steel for double action doors. Square French spindle.

AC214

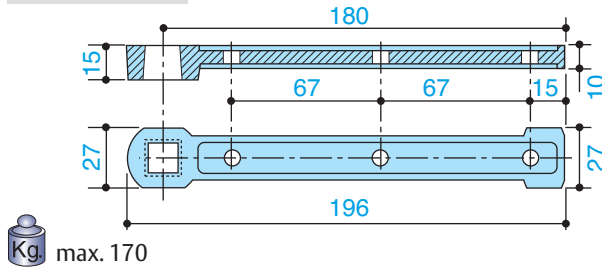

max. 170

Codice / Code

Perno superiore per porte a ventola. Punto di rotazione registrabile.
Double acting top pivot. Adjustable pivot point.

AC118

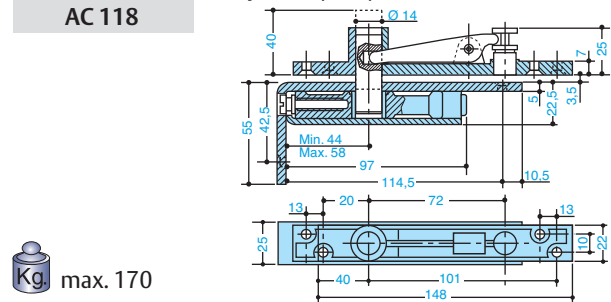

max. 170

Codice / Code

Perno superiore per porte a ventola.
Double acting top pivot.

AC8

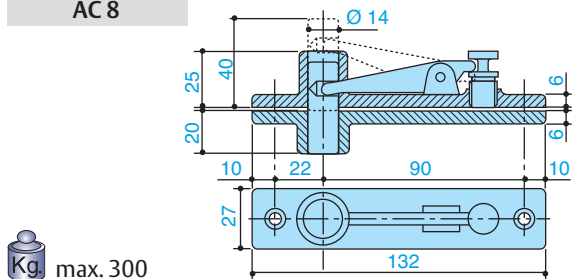

max. 300

Codice / Code

Perno superiore in acciaio massiccio per porte a ventola, con boccia autolubrificante.
Double acting top pivot in full steel with self lubricating bushing.

AC375

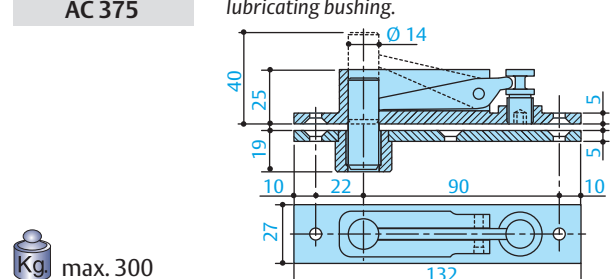

max. 300

Codice / Code

Braccio inferiore destro e sinistro in acciaio per porte a battente, interasse mm. 36.
Right and left bottom arm in steel for single acting doors, 36 mm. offset. Square Italian spindle.

AC583

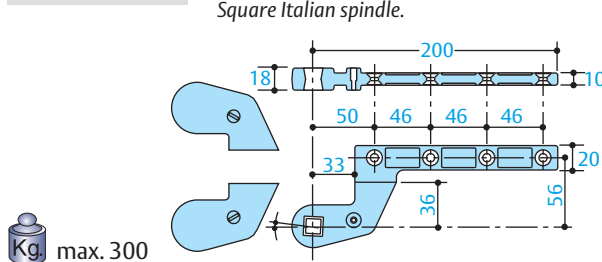

max. 300

Codice / Code

Braccio inferiore destro e sinistro in acciaio per porte a battente, interasse mm. 36.
Right and left bottom arm in steel for single acting doors, 36 mm. offset. Rectangular German socket.

AC392

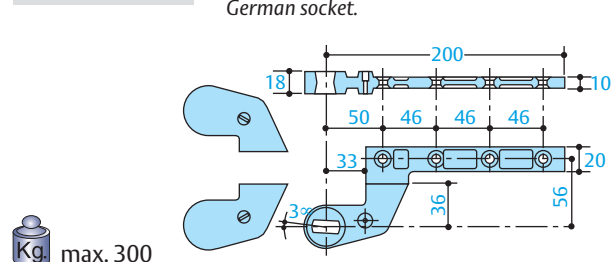

max. 300

Codice / Code

Perno superiore in acciaio per porte a battente sinistre o destre, interasse mm. 36.
Top pivot in steel for left or right doors 36 mm. offset.

AC384

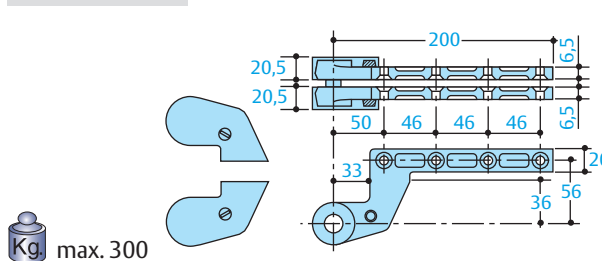

max. 300

Codice / Code

Perno superiore in ottone naturale con cuscinetto a sfere per porte destre o sinistre.
Single acting top pivot in natural brass with ball bearing for right or left doors.

AC7

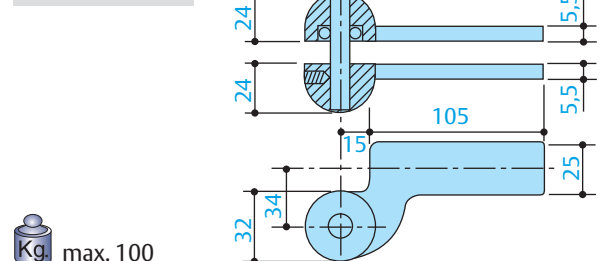

max. 100

Codice / Code

AC 3

Braccio inferiore sinistro in ottone naturale per porte a battente. Cava quadro italiano.
Left bottom arm in natural brass for single acting doors. Square Italian spindle.

max. 100

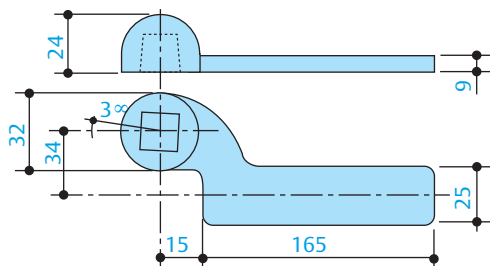

Codice / Code

AC 1

Braccio inferiore destro in ottone naturale per porte a battente. Cava quadro italiano.
Right bottom arm in natural brass for single acting doors. Square Italian spindle.

max. 100

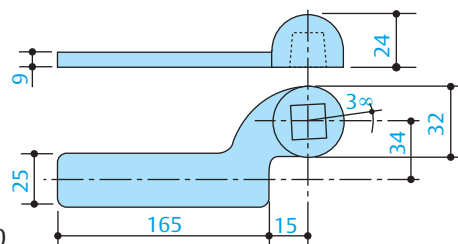

Codice / Code

AC 373

Braccio inferiore destro in acciaio per porte a battente, interasse mm. 36. Cava quadro francese.
Right bottom arm in steel for single acting doors, 36 mm. offset. Square French spindle.

max. 300

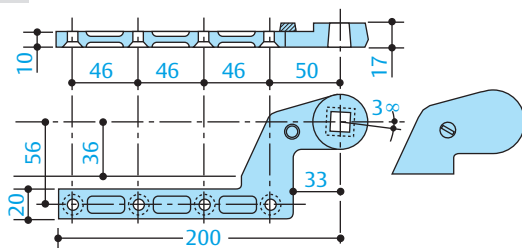

Codice / Code

AC 374

Braccio inferiore sinistro in acciaio per porte a battente, interasse mm. 36. Cava quadro francese.
Left bottom arm in steel for single acting doors, 36 mm. offset. Square French spindle.

max. 300

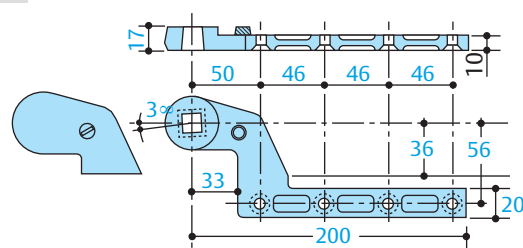

Codice / Code

AC 261

Prolunga + 23 mm. in acciaio per quadro italiano.
Extension +23 mm. in steel for square Italian spindle.

max. 300

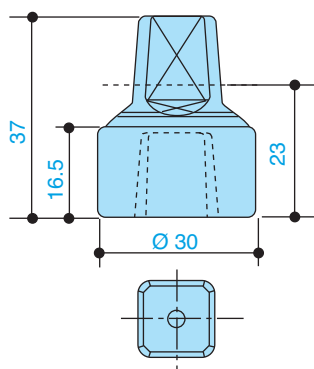

Perni intercambiabili
Detachable spindles

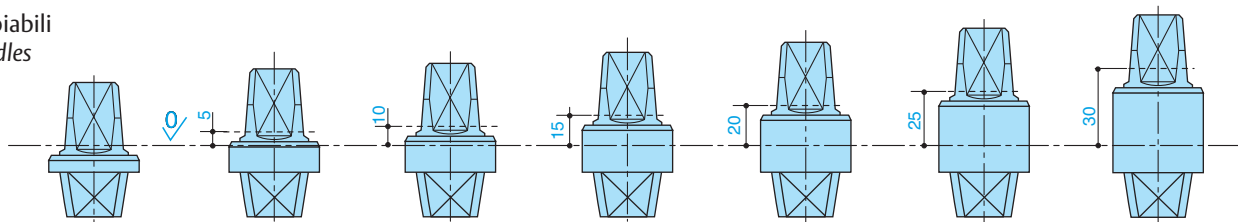

Codice / Code	Codice / Code	Codice / Code	Codice / Code	Codice / Code	Codice / Code	Codice / Code
AC 340	AC 341	AC 342	AC 343	AC 344	AC 345	AC 346
AC 350	AC 351	AC 352	AC 353	AC 354	AC 355	AC 356
AC 360	AC 361	AC 362	AC 363	AC 364	AC 365	AC 366

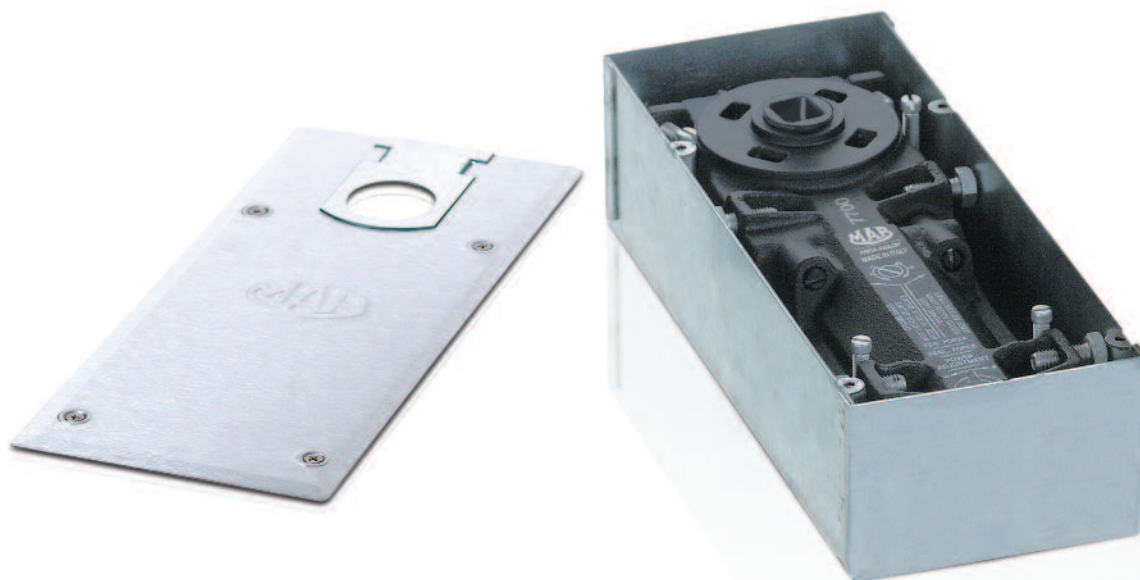

ASSA ABLOY Italia S.p.A.
San Giovanni in Persiceto (BO) Italy
Tel. +39 051 6812411 - Fax +39 051 827486
info@assaabloy.it - www.assaabloy.it

ASSA ABLOY is the global leader in door opening solutions, dedicated to satisfying end-user needs for security, safety and convenience.

www.assaabloy.com



ASSA ABLOY Italia S.p.A. si riserva di apportare in qualunque momento e senza preavviso le modifiche necessarie per migliorare ed evolvere le caratteristiche dei propri prodotti. Fotografie, illustrazioni e descrizioni sono da ritenersi indicative. ASSA ABLOY Italia S.p.A. reserves the right at any time and without notice, the necessary modifications in order to improve and evolve the characteristics of their products. Photographs, illustrations and descriptions ought to be considered as indicative.

H001E25 / 01-2011