

CIERRES EMBUTIDOS

Folleto General

OLÉ BASE



En Herralum ponemos a tu disposición los nuevos cierres embutidos Olé Base FAPIM fabricados en Italia, con grandes ventajas funcionales, de diseño e instalación para ventanas y puertas corredizas de las series comerciales más vendidas en México.

¡Conócelas ya!

- Enganche rápido sin tornillo a la vista
- Plantilla posicionadora de ganchos
- Con modo de uso manual o automático
- Indicador de CERRADO color rojo
- Tolerancia en el resaque de hasta 7 mm
- Opresor interno para un montaje firme del cuerpo
- Probado en laboratorio por más de 25,000 ciclos

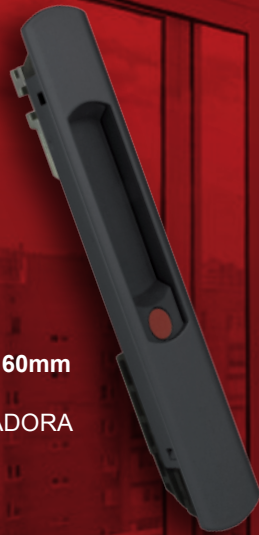

fapim®

Life in evolution

Made in Italy



1382052

CIERRE OLÉ BASE CORTO 160mm
(5000BB FAPIM)

*CON PLANTILLA POSICIONADORA DE GANCHOS

ACABADOS

1382053

CIERRE OLÉ BASE LARGO 200mm
(5002BB FAPIM)

*CON PLANTILLA POSICIONADORA DE GANCHOS

ACABADOS

Resaque en perfil para cierre 1382052

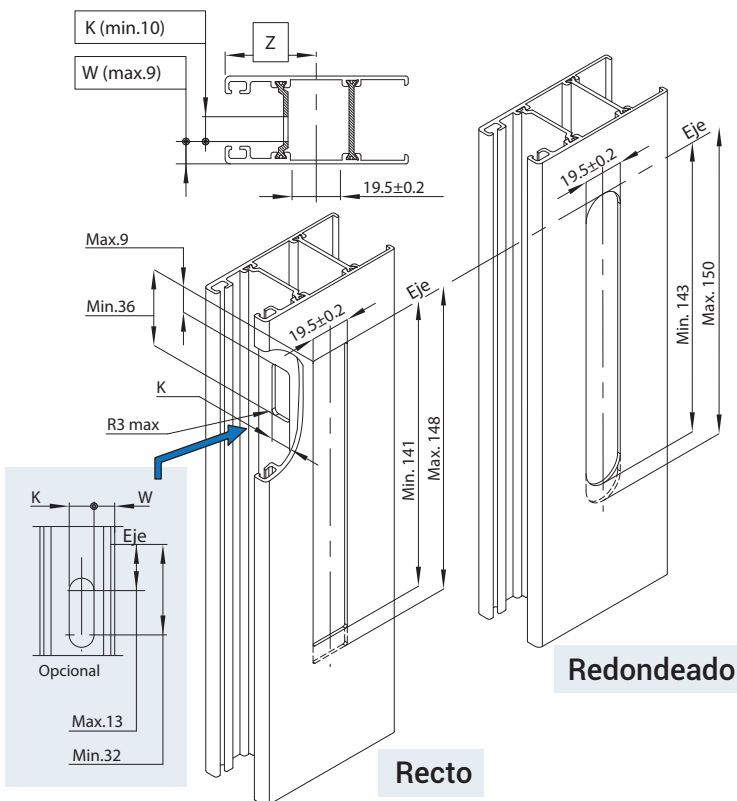

Resaque en perfil para cierre 1382053

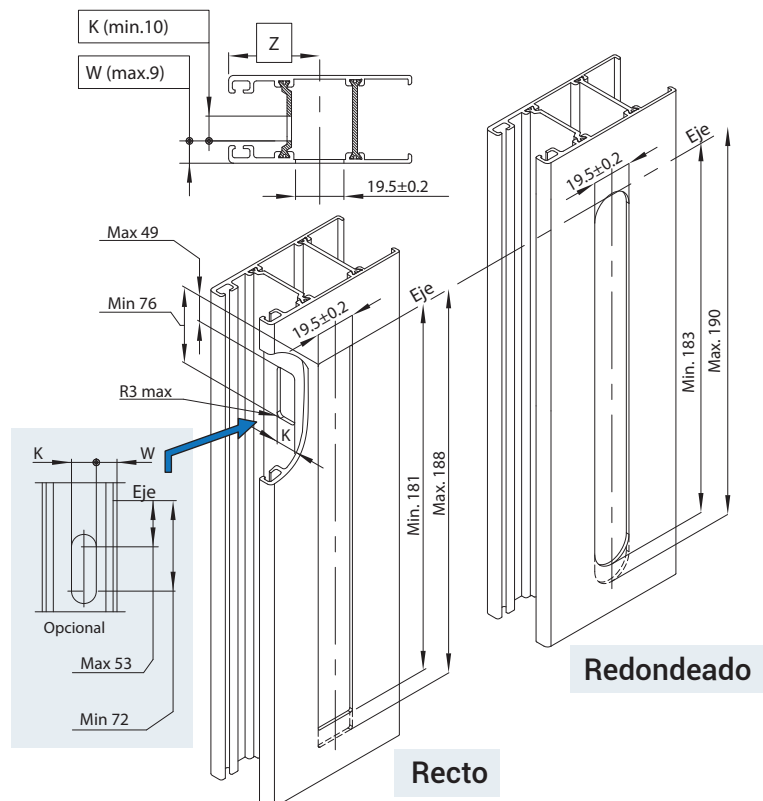

GANCHO+CONTRA

OPTIMIZACIÓN DE KITS DE ENGANCHES



138205400

KIT 5024B+5030B FAPIM

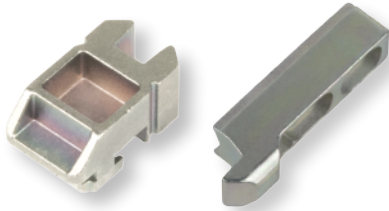

CUPRUM

Serie 150

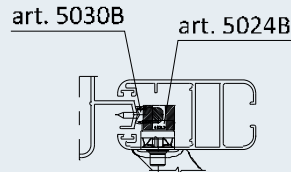

EXTRUSIONES METÁLICAS

Serie 10000

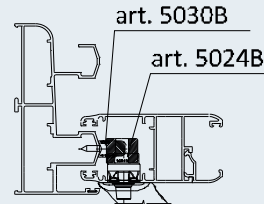

INDALUM

Serie 4500

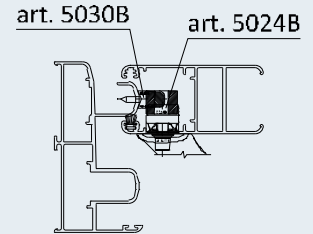

138205500

KIT 5022A+5029 FAPIM



CUPRUM

Serie 80

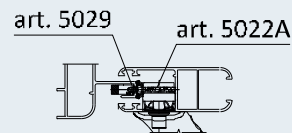

EXTRUSIONES METÁLICAS

Serie 4600

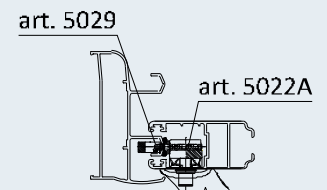

138205600

KIT 5024A+5030A FAPIM

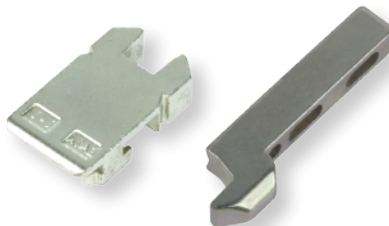

INDALUM

Serie 4000

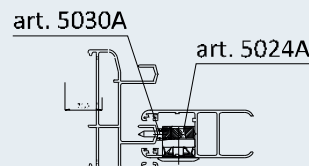

ALUGAMA

Serie 4100

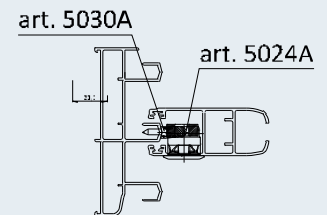

138205700

KIT 5023D+5032A FAPIM



CUPRUM

Serie 60

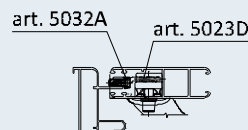

INDALUM

Serie 2500

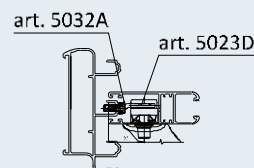

PROFILO

Serie Ragazza

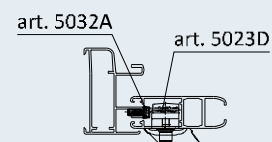

PROFILO

Serie Finestra

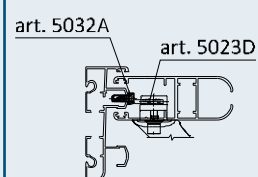

GANCHO+CONTRA

OPTIMIZACIÓN DE KITS DE ENGANCHES



138205800

KIT 5023B+5030B FAPIM

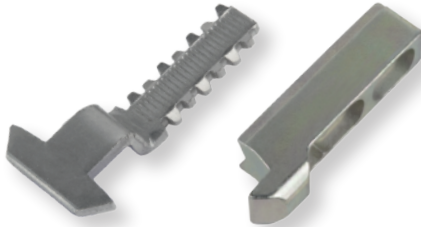

Línea 3"

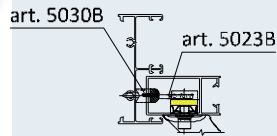

Línea 3"

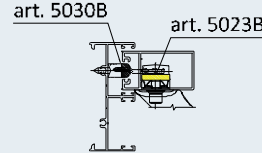

Serie 70

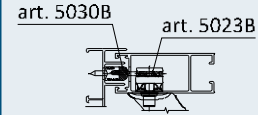

Serie 3800

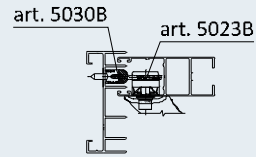

138205900

KIT 5023N+5030B FAPIM



Serie 100 (VIEJA)

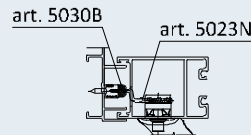

138206000

KIT 5023CA+5030C FAPIM



Serie 3900

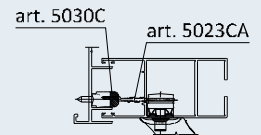

RESAQUE EN PERFIL PARA CONTRAS

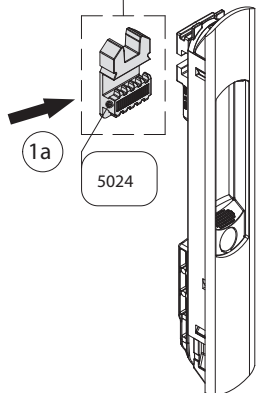
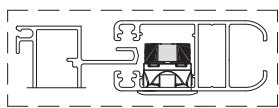

1a

5024

5...

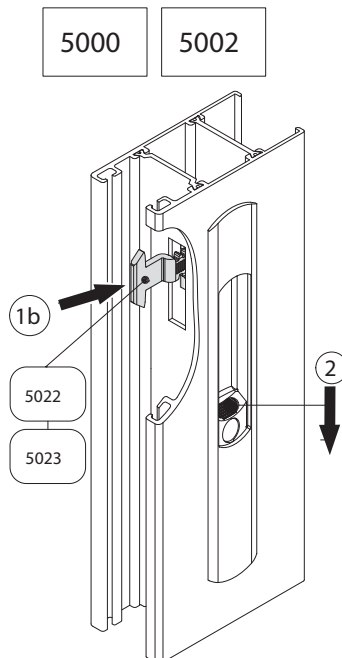

1b

5022

5023

2

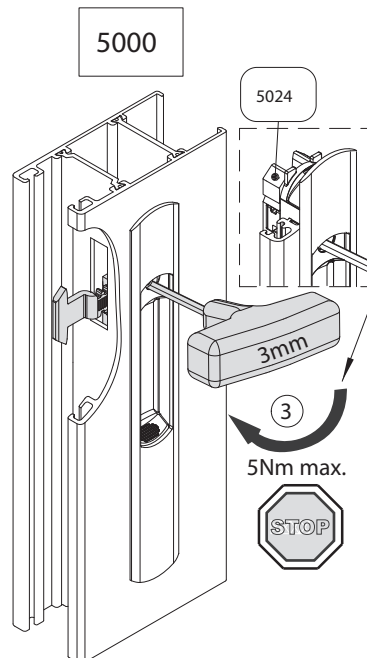

3mm

3

5Nm max.

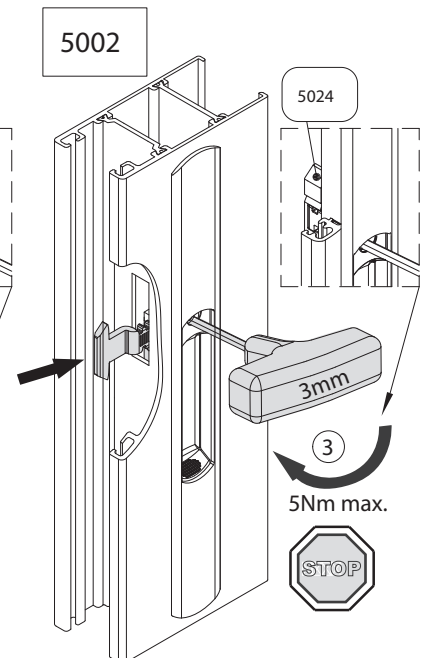

3mm

3

5Nm max.



PLANTILLAS POSICIONADORAS DE GANCHOS

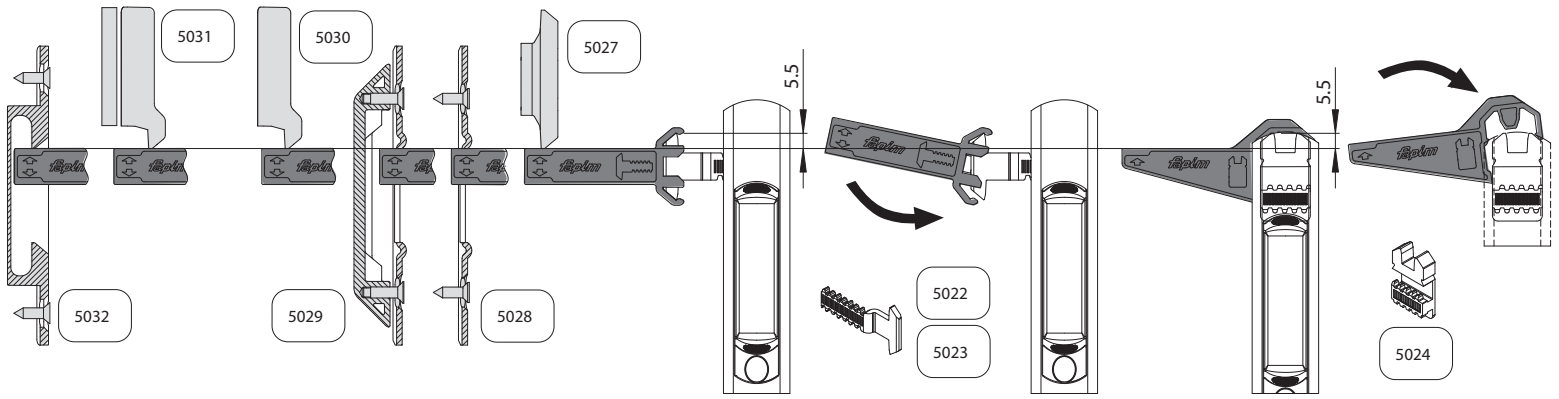

RESAQUE EN PERFIL PARA CONTRAS

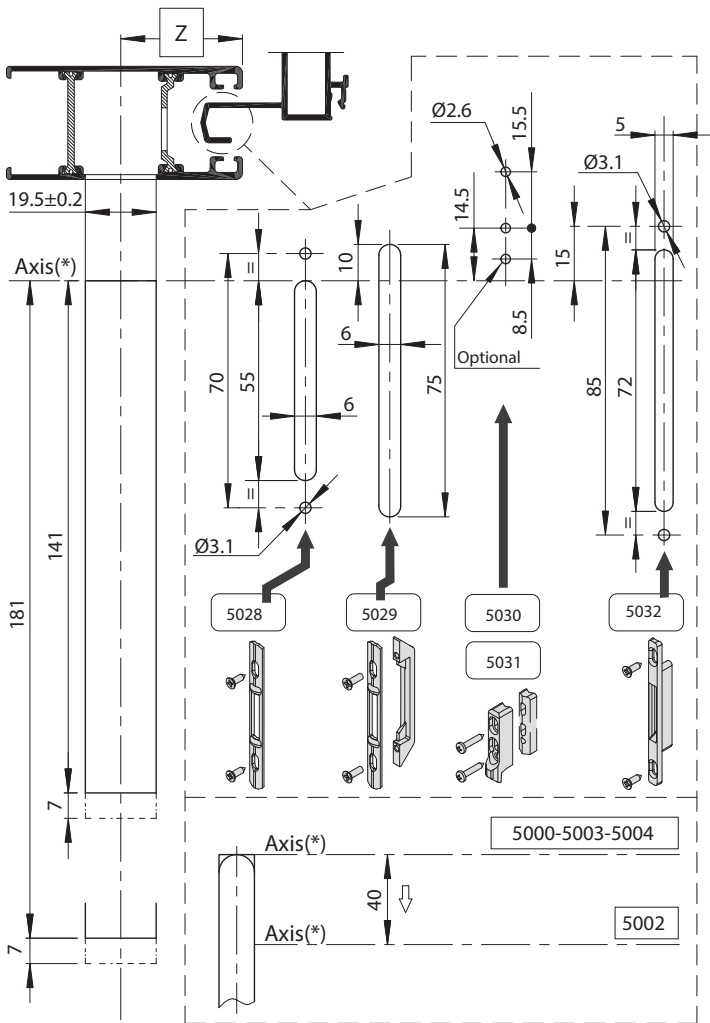

INSTALACIÓN DE CIERRES EMBUTIDOS

