

Fichas técnicas

The logo for axlent italy features the word 'axlent' in a bold, lowercase, sans-serif font. The letter 'x' is stylized with a curved line through it. Below 'axlent' is the word 'italy' in a smaller, lowercase, sans-serif font. The logo is set against a background of a large green diagonal shape that spans the right side of the page.

axlent
italy

The background of the left side of the page is a collage of images showing various glass door hardware components, including handles, locks, and hinges, arranged in a diamond-shaped grid pattern.

Zaragoza No. 2,
Col. Los Remedios,
Naucalpan de Juárez,
México, C.P. 53400

Tels.: 55 70 95 47 34 y 55 71 58 59 73

✉ atencion.italiamed@gmail.com

Herrajes para vidrio templado

Contenido



1

Cerradores.
Sistemas corredizos.
Cerraduras.

10

Jaladeras.
Clips.
Bisagras.
Separadores.

24

Soportes.
Complementos.
Conectores.
Herrajes.
Bases para tubo.
Bridas.
Punto de giro.
Kit de sistema hidráulico.

30

Contenido
por clave.

axlent
i t a l y

XH-073



Cerrador de puerta auto.

- Soporta: 120 kg.
- Acabado: Electrostático.
- Color: Plateado.

XH-072



Cerrador de puerta auto.

- Soporta: 80 kg.
- Acabado: Electrostático.
- Color: Plateado.

XH-071



Cerrador de puerta auto.

- Soporta: 65 kg.
- Acabado: Electrostático.
- Color: Plateado.

XH-1501



Cerrador de puerta oculto.

- Soporta: 65-80 kg.
- Acabado: Electrostático.
- Color: Plateado.

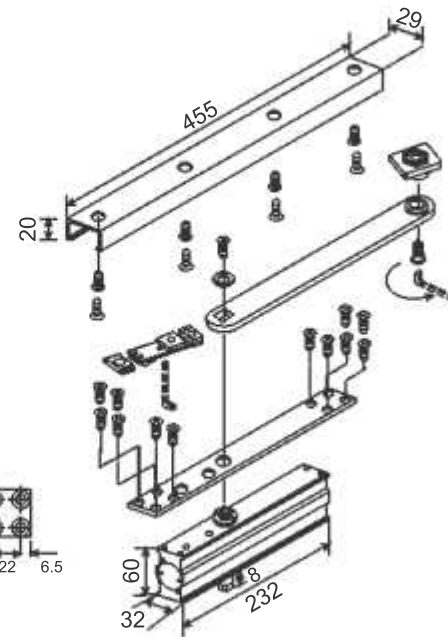
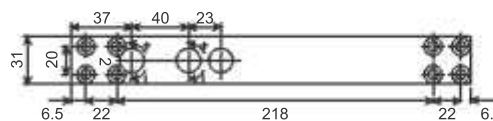

**CERRADOR
INSTALADO**



**SOPORTE DE
CONEXIÓN**

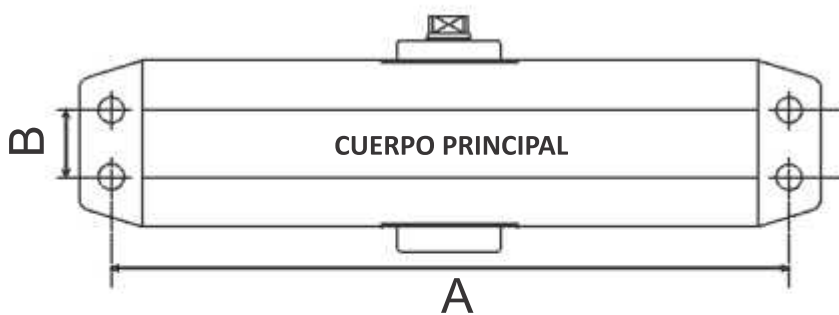
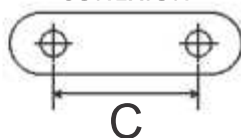

Modelo	A	B	C
XH-073	230	19	45
XH-072	188	20	40.5
XH-071	165	20	40.5

XH-1601



Cerrador de puerta oculto.

- Soporta: 65-80 kg.
- Acabado: Electrostático.
- Color: Plateado.

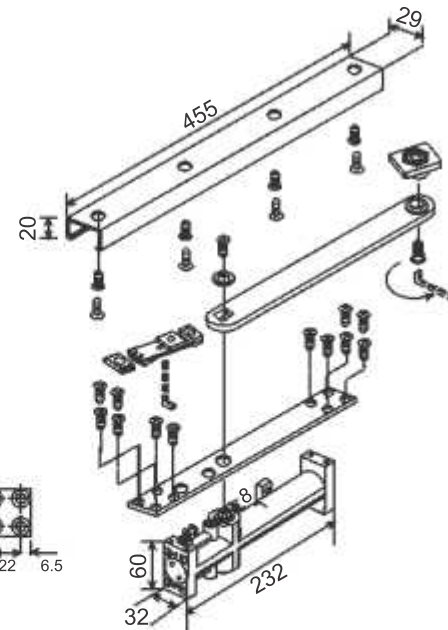
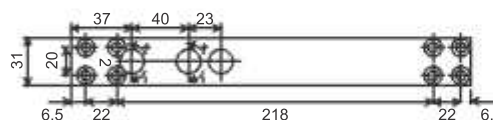

KH01



Sistema corredizo sin tubo.
 • Para: 8-10 mm.
 • Material: Acero inox. 304
 • Acabado: Cromo.

KH01Z



Sistema corredizo sin tubo.
 • Para: 8-10 mm.
 • Material: Zamack.
 • Acabado: Cromo.

KH01S



Sistema corredizo sin tubo.
 • Para: 8-10 mm.
 • Material: Acero inox. 304
 • Acabado: Satín.

KH02



Sistema corredizo sin tubo.
 • Para: 10-12 mm.
 • Material: Acero inox. 304
 • Acabado: Satín.

N0115



Escuadra para sistema corredizo.
 • Material: Acero inox. 304
 • Acabado: Satín.

N0208



Soporte a muro de sistema corredizo.
 • Material: Acero inox. 304
 • Acabado: Satín.

O15C • O15S



Tubo (riel) cuadrado para sistema corredizo
 • Tamaño: 10 x 30 mm
 • Largo: 1.5 m
 • Calibre: 16
 • Compatible: KH01/KH01Z/KH01S
 • Material: Acero inox.
 • Acabado: O15C Cromo, O15S Satín.

R6M



Tubo redondo para sistema corredizo
 • Tamaño: 1 pulgada
 • Largo: 6 m
 • Calibre: 16
 • Compatible: KH02
 • Material: Acero inox.
 • Acabado: Satín.

R3M



Tubo redondo para sistema corredizo
 • Tamaño: 1 pulgada
 • Largo: 3 m
 • Calibre: 16
 • Compatible: KH02
 • Material: Acero inox.
 • Acabado: Satín.

MODELOS KH01 / KH01-Z / KH01-S

Soporta: 70 kg Largo máximo: 1.8 m

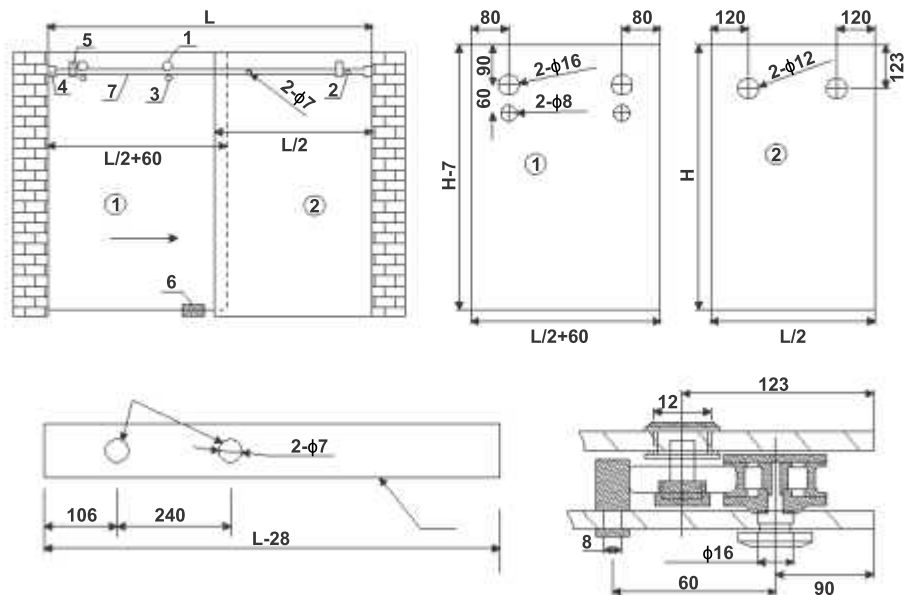

MODELO KH02

Soporta: 150 kg Largo máximo: 2.5 m

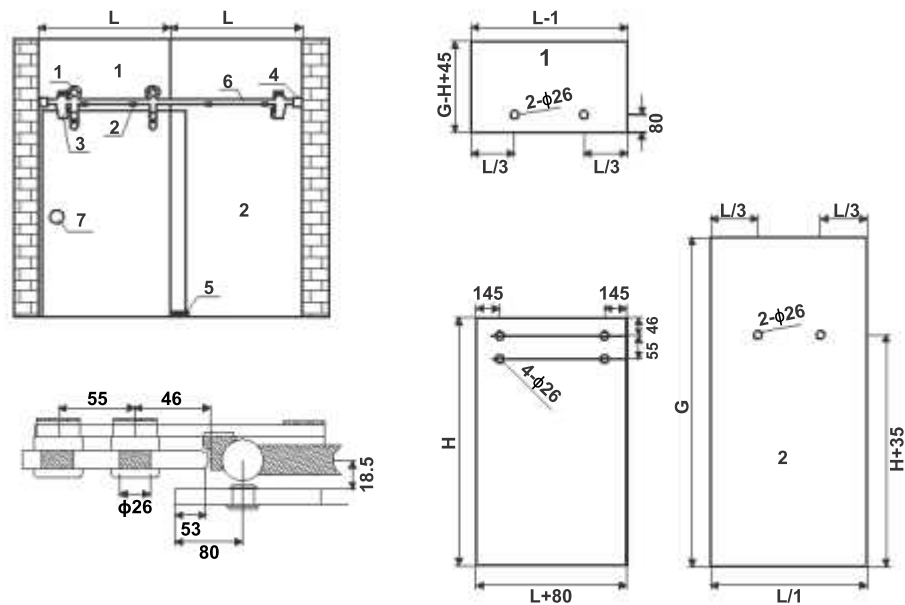

XH-82801



Cerradura de puerta de cristal de mariposa.

- Para: 10-12 mm.
- Material: Acero inox.
- Acabado: Satín.

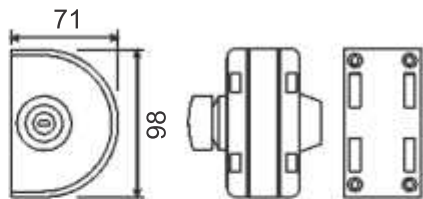

XH-82802



Cerradura de puerta de cristal plana.

- Para: 10-12 mm.
- Material: Acero inox.
- Acabado: Satín.

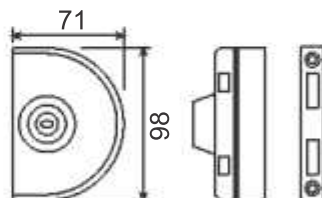

XH-82803



Cerradura de puerta de cristal doble de mariposa.

- Para: 10-12 mm.
- Material: Acero inox.
- Acabado: Satín.

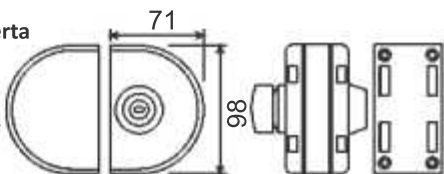

XH-82804



Cerradura de puerta de cristal doble plana.

- Para: 10-12 mm.
- Material: Acero inox.
- Acabado: Satín.

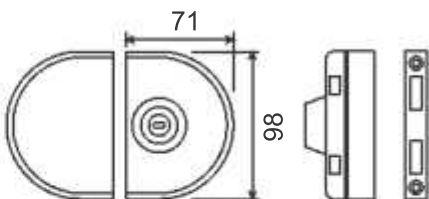

XH-82805



Cerradura de puerta de cristal de doble llave.

- Para: 10-12 mm.
- Material: Acero inox.
- Acabado: Satín.

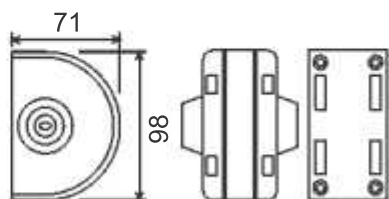

XH-82806



Cerradura de puerta de cristal doble de doble llave.

- Para: 10-12 mm.
- Material: Acero inox.
- Acabado: Satín.

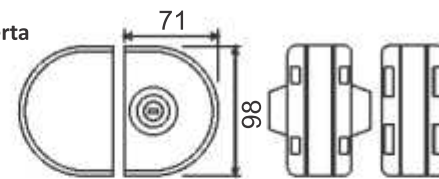

MODELOS XH-82801 AL XH-82806

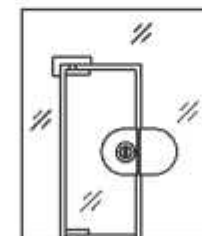
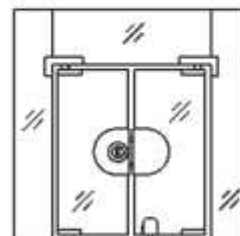
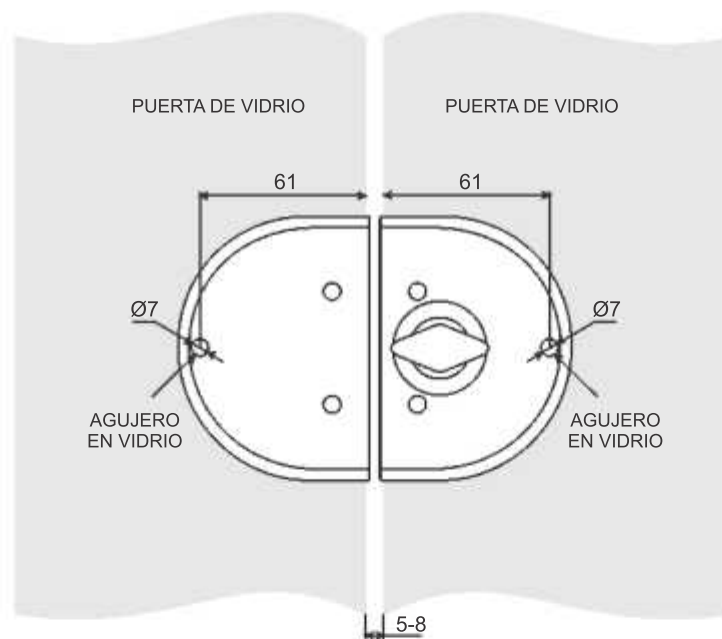

XH-83101



Cerradura con mango.

- Para: 8-12 mm.
- Material: Acero inox.
- Acabado: Satín.

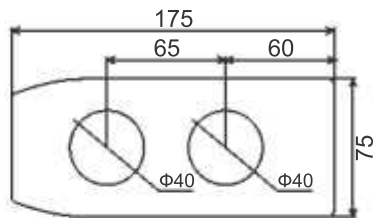

XH-83102P



Contra para cerradura con mango.

- Para: 8-12 mm.
- Material: Acero inox.
- Acabado: Satín.

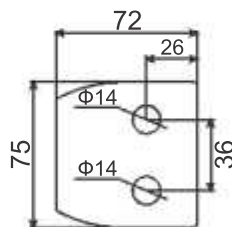

XH-83301



Cerradura de puerta corrediza.

- Para: 10-15 mm.
- Material: Acero inox. 304.
- Acabado: Satín.

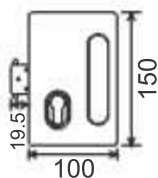

XH-83302



Cerradura de puerta corrediza doble.

- Para: 10-15 mm.
- Material: Acero inox. 304.
- Acabado: Satín.

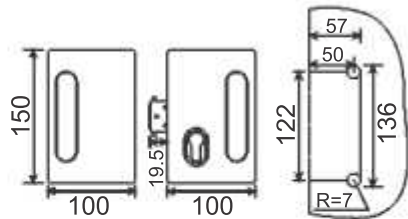

XH-84201



Cerradura de armario de cristal.

- Para: 6-12 mm.
- Material: Acero inox.
- Acabado: Satín.

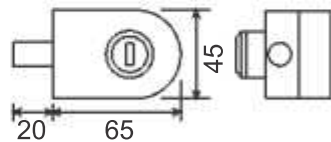

XH-84202



Cerradura de armario de cristal doble.

- Para: 6-12 mm.
- Material: Acero inox.
- Acabado: Satín.

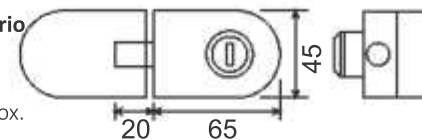

XH-84801



Cerradura de gancho para puerta.

- Para: 10-12 mm.
- Material: Acero inox.
- Acabado: Satín.

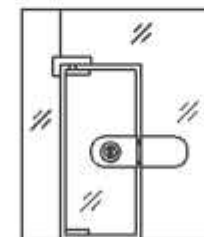
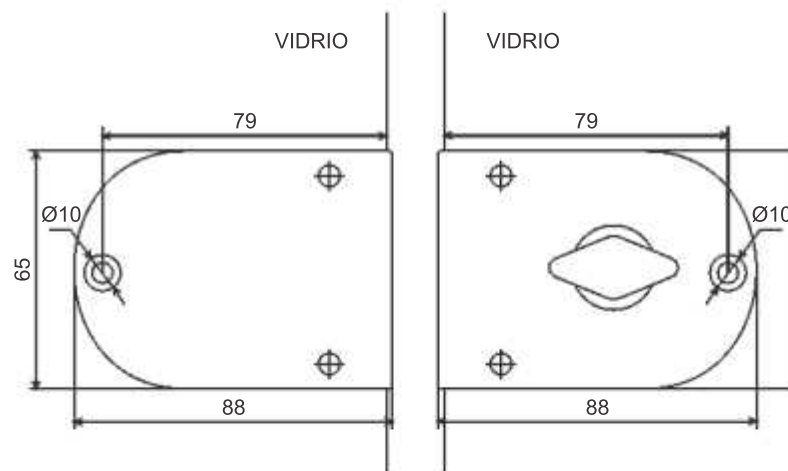
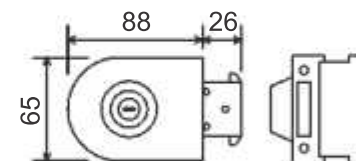

XH-84802P



Contracara para cerradura de gancho.

- Para: 10-12 mm.
- Material: Acero inox.
- Acabado: Satín.

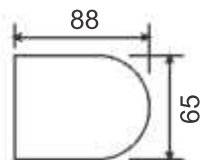

D-050



Cerradura de esquina

- Para: 8-12 mm.
- Material: Acero inox. 304.
- Acabado: Satín.

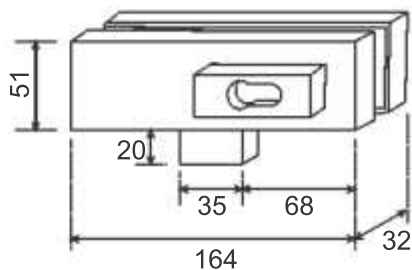

CORTE DE VIDRIO

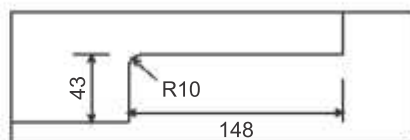

K-246-C • K-246-S



Jaladera 30*30.

- Material: Aluminio.
- Acabado:
K-246-C Cromo.
K-246-S Satín.

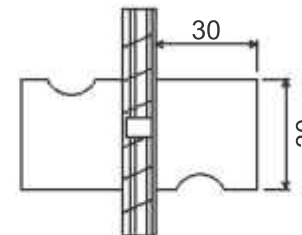

K-247-C • K-247-S



Jaladera 30*30.

- Material: Aluminio.
- Acabado:
K-247-C Cromo.
K-247-S Satín.

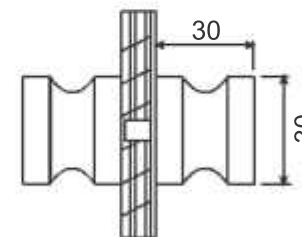

K-264-C • K-264-S



Jaladera 30*30.

- Material: Aluminio.
- Acabado:
K-264-C Cromo.
K-264-S Satín.

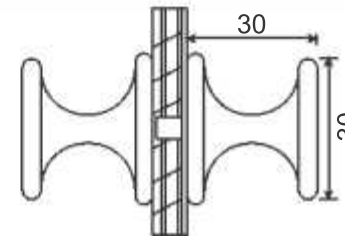

K-276-C • K-276-S



Jaladera 30*30.

- Material: Aluminio.
- Acabado:
K-276-C Cromo.
K-276-S Satín.

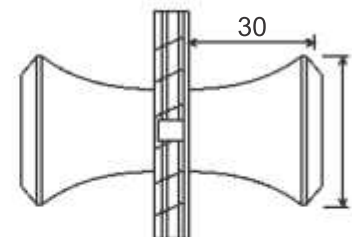

25*300-C



Jaladera de 30.

- Para: 8-12 mm.
- Material: Acero inox.
- Acabado: Cromo.

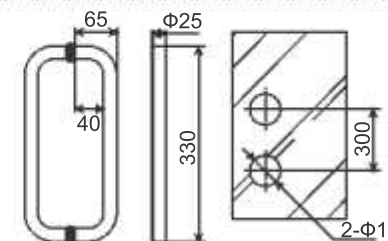

25*300-SN



Jaladera de 30.
 •Para: 8-12 mm.
 •Material: Acero inox.
 •Acabado: Satín.

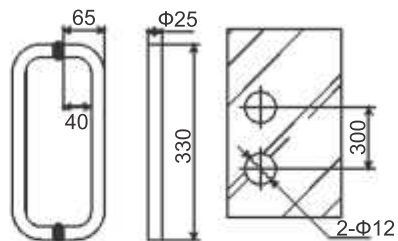

19*150-C



Jaladera de 15.
 •Para: 8-12 mm.
 •Material: Acero inox.
 •Acabado: Cromo.

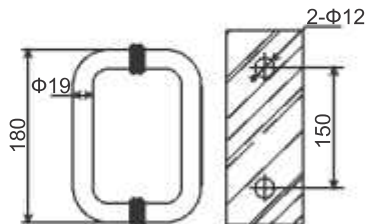

19*150-SN



Jaladera de 15.
 •Para: 8-12 mm.
 •Material: Acero inox.
 •Acabado: Satín.

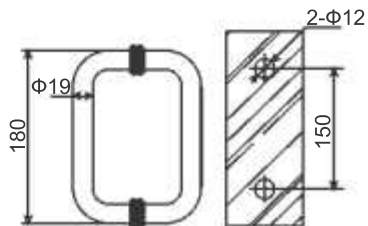

SH-250-50 • SH-250-90 • SH-250-120



Jaladera tipo H de 1-1/4.
 •Material: Acero inox. 304.
 •Acabado: Satín.
 •SH-250-50 (50 cm) centros a 30 cm.
 •SH-250-90 (90 cm) centros a 50 cm.
 •SH-250-120 (120 cm) centros a 80 cm.

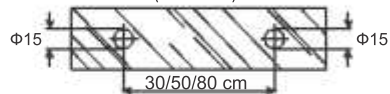

SH-530

Jaladera toallero 20*45
 •Material: Acero inox. 304.
 •Acabado: Satín.

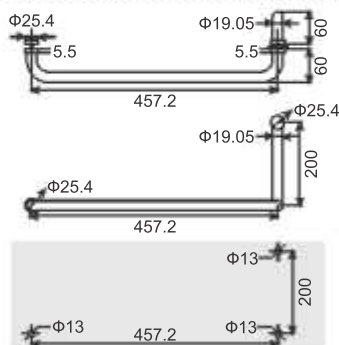

K-121-12-C • K-121-12-S



Clip para cristal.
 •Para: 12 mm.
 •Soporta: 15 kg.
 •Material: Zamak
 •Acabado:
 K-121-12-C Cromo.
 K-121-12-S Satín.

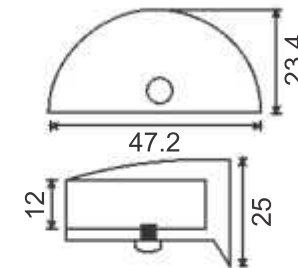

K-128-12-C • K-128-12-S



Clip para cristal.
 •Para: 12 mm.
 •Soporta: 15 kg.
 •Material: Zamak.
 •Acabado:
 K-128-12-C Cromo.
 K-128-12-S Satín.

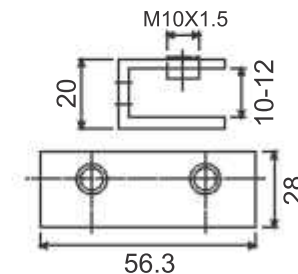

K-169-C • K-169-S



Clip.
 •Para: 5-15 mm.
 •Soporta: 25 kg.
 •Material: Zamak.
 •Acabado:
 K-169-C Cromo.
 K-169-S Satín.

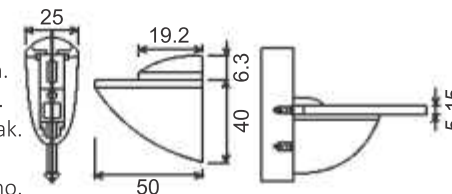

K-170-C • K-170-S



Clip.
 •Para: 5-25 mm.
 •Soporta: 35 kg.
 •Material: Zamak.
 •Acabado:
 K-170-C Cromo.
 K-170-S Satín.

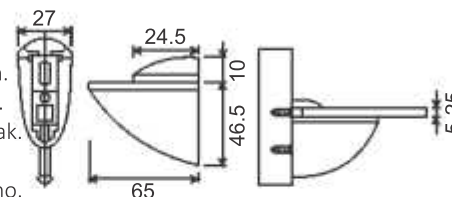

K-170-1-C • K-170-1-S



Clip.
 •Para: 5-30 mm.
 •Soporta: 55 kg.
 •Material: Zamak.
 •Acabado:
 K-170-1-C Cromo.
 K-170-1-S Satín.

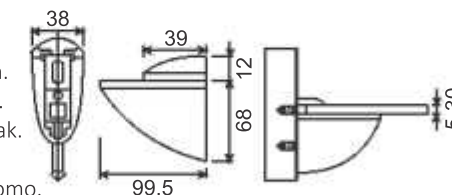

K-826



Clip.

- Para: 5-15 mm.
- Soporta: 20 kg.
- Material: Zamak.
- Acabado: Níquel perlado.

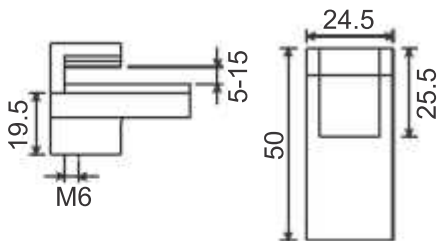

K-166



Clip.

- Para: 3-25 mm.
- Soporta: 35 kg.
- Material: Zamak.
- Acabado: Satín.

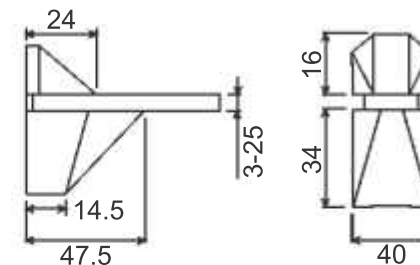

K-827



Clip.

- Para: 5-20 mm.
- Soporta: 20 kg.
- Material: Zamak.
- Acabado: Níquel perlado.

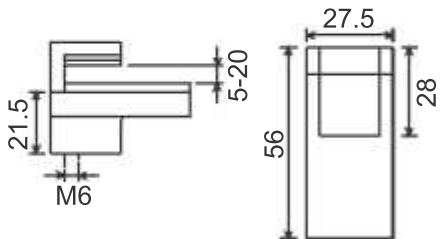

K-822



Clip.

- Para: 8 mm.
- Soporta: 15 kg.
- Material: Acero inox.
- Acabado: Satín.
- Venta por par.

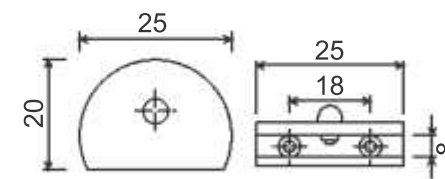

K-163



Clip.

- Para: 3-30 mm.
- Soporta: 35 kg.
- Material: Zamak.
- Acabado: Níquel perlado.

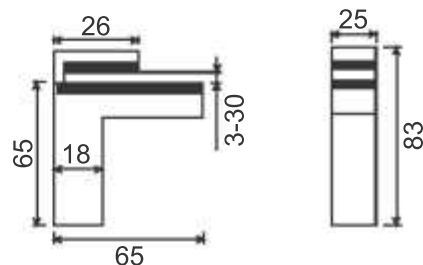

K-823



Clip.

- Para: 10 mm.
- Soporta: 15 kg.
- Material: Acero inox.
- Acabado: Satín.
- Venta por par.

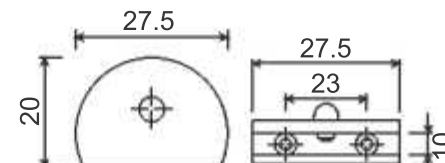

K-163-1



Clip.

- Para: 3-40 mm.
- Soporta: 55 kg.
- Material: Zamak.
- Acabado: Níquel perlado.

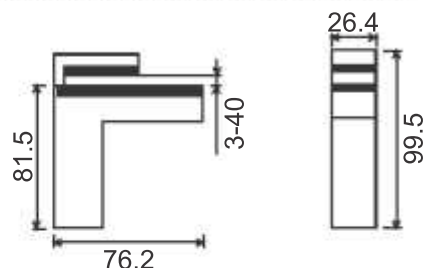

K-824



Clip.

- Para: 12 mm.
- Soporta: 15 kg.
- Material: Acero inox.
- Acabado: Satín.
- Venta por par.

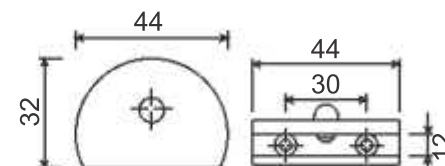

K-165



Clip.

- Para: 3-15 mm.
- Soporta: 20 kg.
- Material: Zamak.
- Acabado: Satín.

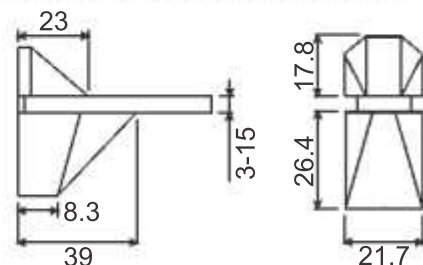

K-153-C • K-153-S



Clip de fijación base plana.

- Para: 8-12 mm.
- Soporta: 30 kg.
- Material: Zamak.
- Acabado: K-153-C Cromo. K-153-S Satín.

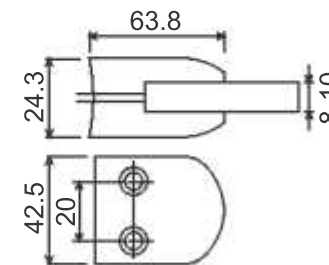

K-153-1-C • K-153-1-S



Clip de fijación base curva.

- Para: 8-12 mm.
- Soporta: 30 kg.
- Material: Zamak.
- Acabado:
K-153-1-C Cromo.
K-153-1-S Satín.

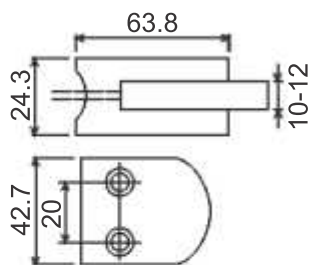

K-869-C • K-869-S



Clip de fijación base curva.

- Para: 6-10 mm.
- Soporta: 30 kg.
- Material: Acero inox.
- Acabado:
K-869-C Cromo.
K-869-S Satín.

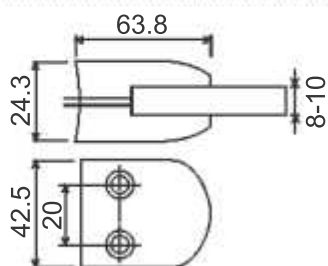

K-870-C • K-870-S



Clip de fijación base plana.

- Para: 6-10 mm.
- Soporta: 30 kg.
- Material: Acero inox.
- Acabado:
K-870-C Cromo.
K-870-S Satín.

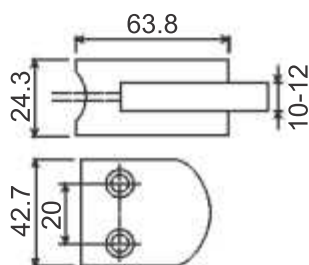

K-510-C • K-510



Clip 135°.

- Para: 8-10 mm.
- Soporta: 50 kg.
- Material: Acero inox.
- Acabado:
K-510-C Cromo.
K-510 Satín.

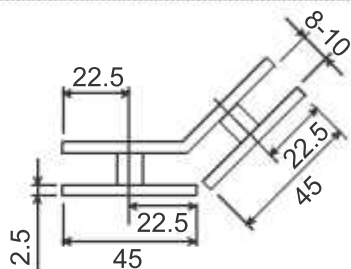

K-512-C • K-512



Clip 180°.

- Para: 8-10 mm.
- Soporta: 50 kg.
- Material: Acero inox.
- Acabado:
K-512-C Cromo.
K-512 Satín.

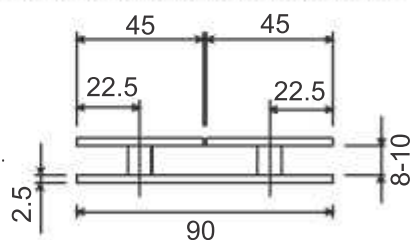

K-513



Clip.

- Para: 8-10 mm.
- Soporta: 50 kg.
- Material: Acero inox.
- Acabado: Satín.

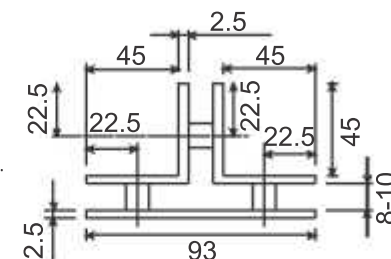

K-518-C • K-518



Clip.

- Para: 8-10 mm.
- Soporta: 50 kg.
- Material: Acero inox.
- Acabado:
K-518-C Cromo.
K-518 Satín.

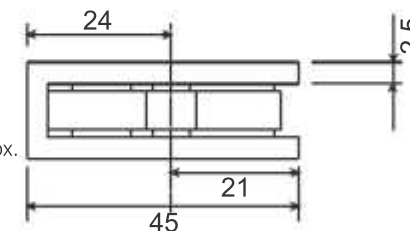

K-507-C • K-507



Clip 90°.

- Para: 8-10 mm.
- Soporta: 50 kg.
- Material: Acero inox.
- Acabado:
K-507-C Cromo.
K-507 Satín.

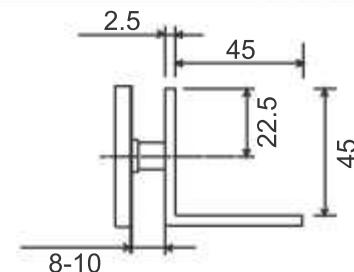

K-508-C • K-508



Clip 90°.

- Para: 8-10 mm.
- Soporta: 50 kg.
- Material: Acero inox.
- Acabado:
K-508-C Cromo.
K-508 Satín.

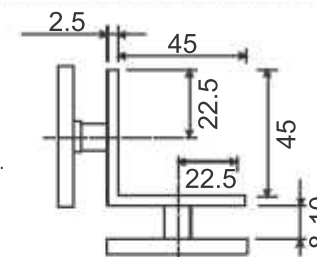

K-858-C • K-858-S



Bisagra.

- Para: 6 mm.
- Soporta: 20 kg.
- Material: Zamak.
- Acabado:
K-858-C Cromo.
K-858-S Satín.

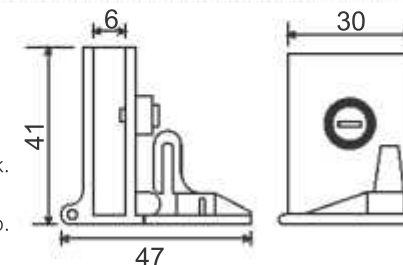

K-861-C • K-861-S



Bisagra.

- Para: 10 mm.
- Soporta: 35 kg.
- Material: Zamak.
- Acabado:
K-861-C Cromo.
K-861-S Satín.

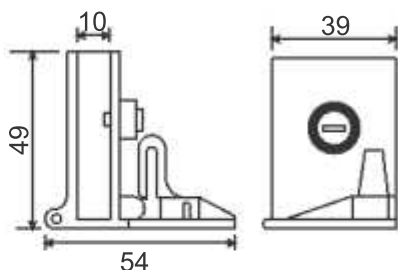

K-862-C • K-862-S



Bisagra.

- Para: 10 mm.
- Soporta: 50 kg.
- Material: Zamak.
- Acabado:
K-862-C Cromo.
K-862-S Satín.

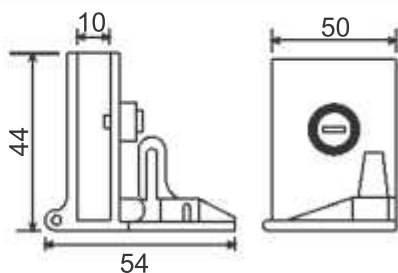

K-844



Bisagra plana.

- Para: 8 mm.
- Soporta: 25 kg.
- Material: Zamak.
- Acabado: Satín.

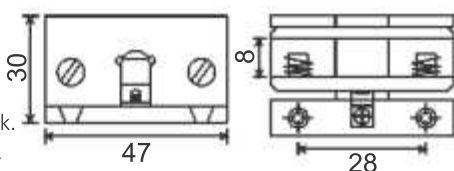

K-846



Bisagra curva.

- Para: 10 mm.
- Soporta: 25 kg.
- Material: Zamak.
- Acabado: Satín.

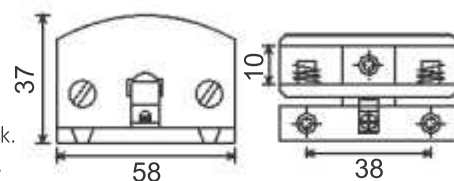

K-174-10



Bisagra.

- Para: 8-10 mm.
- Soporta: 35 kg.
- Material: Acero inox.
- Acabado: Satín.

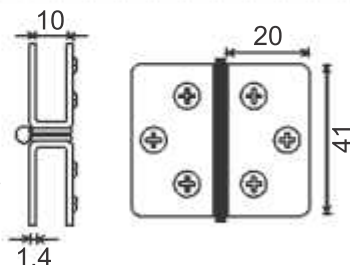

K-946



Bisagra.

- Para: 6-10 mm.
- Soporta: 30 kg.
- Material: Acero inox.
- Acabado: Satín.
- Venta por set.

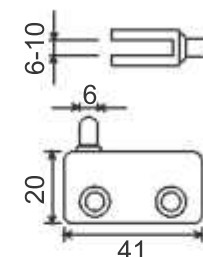

K-947



Bisagra.

- Para: 10-12 mm.
- Soporta: 30 kg.
- Material: Acero inox.
- Acabado: Satín.
- Venta por set.

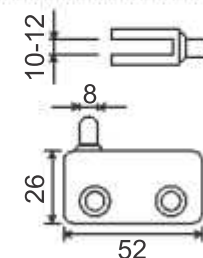

K-803



Bisagra.

- Para: 8 mm.
- Soporta: 35 kg.
- Material: Zamak.
- Acabado: Satín.

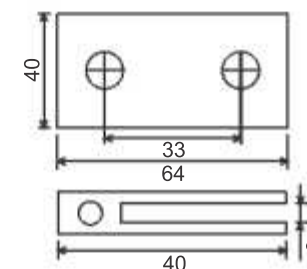

ZL6214-C • ZL6214-SN



Bisagra muro a cristal centrada.

- Para: 8-12 mm.
- Soporta: 25 kg.
- Material: Zamak.
- Acabado:
ZL6214-C Cromo.
ZL6214-SN Satín.

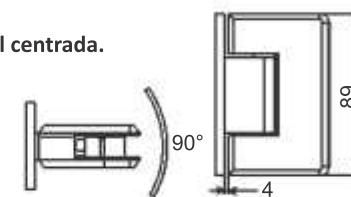

ZL6215-C • ZL6215-SN



Bisagra muro a cristal desfasada.

- Para: 8-12 mm.
- Soporta: 25 kg.
- Material: Zamak.
- Acabado:
ZL6215-C Cromo.
ZL6215-SN Satín.

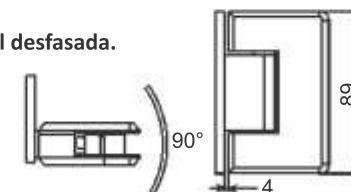

MODELOS ZL6214 / ZL6215

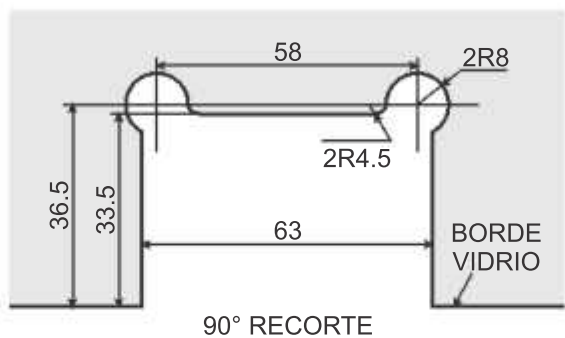

MODELOS Z6216 / Z6217 / Z6218

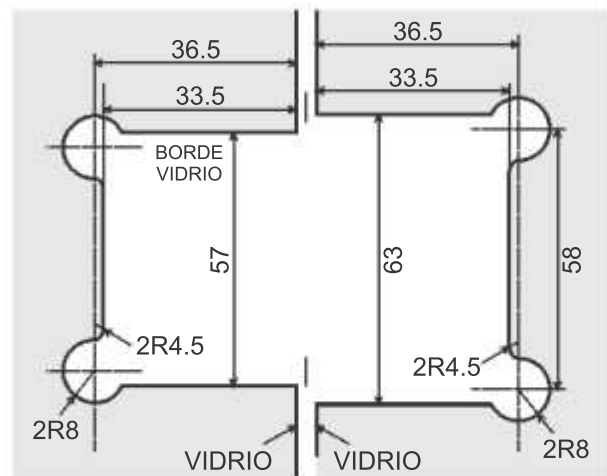

Z6216-C • Z6216-SN



Bisagra cristal a cristal 135°.

- Para: 8-12 mm.
- Soporta: 25 kg.
- Material: Zamak.
- Acabado:
Z6216-C Cromo.
Z6216-SN Satín.

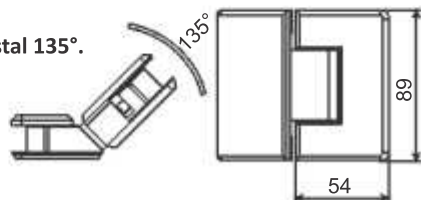

SH310-C • SH310-S



Bisagra muro a cristal desfasada.

- Para: 8-12 mm.
- Soporta: 25 kg.
- Material: Acero inox. 304.
- Acabado:
SH310-C Cromo.
SH310-S Satín.

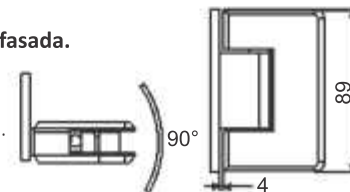

Z6217-C • Z6217-SN



Bisagra cristal a cristal 180°.

- Para: 8-12 mm.
- Soporta: 25 kg.
- Material: Zamak.
- Acabado:
Z6217-C Cromo.
Z6217-SN Satín.

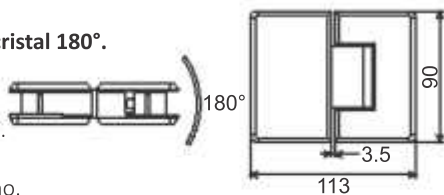

SH320-C • SH320-S



Bisagra muro a cristal centrada.

- Para: 8-12 mm.
- Soporta: 25 kg.
- Material: Acero inox. 304.
- Acabado:
SH320-C Cromo.
SH320-S Satín.

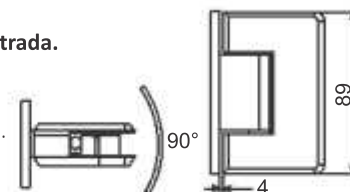

Z6218-C • Z6218-SN



Bisagra cristal a cristal 90°.

- Para: 8-12 mm.
- Soporta: 25 kg.
- Material: Zamak.
- Acabado:
Z6218-C Cromo.
Z6218-SN Satín.

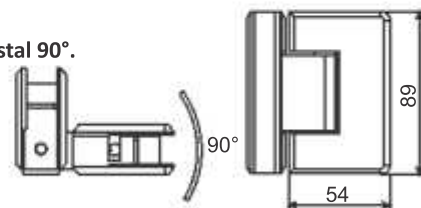

MODELOS SH310 / SH320

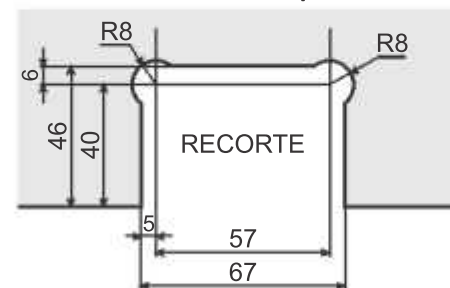

SH330-C • SH330-S



Bisagra cristal a cristal 180°.

- Para: 8-12 mm.
- Soporta: 25 kg.
- Material: Acero inox. 304.
- Acabado: SH330-C Cromo. SH330-S Satín.

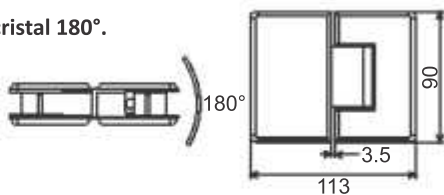

SH340-C • SH340-S



Bisagra cristal a cristal 135°.

- Para: 8-12 mm.
- Soporta: 25 kg.
- Material: Acero inox. 304.
- Acabado: SH340-C Cromo. SH340-S Satín.

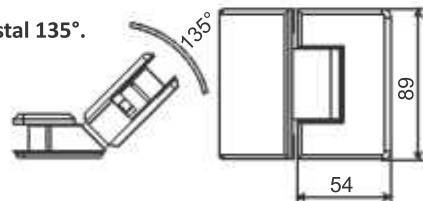

SH350-C • SH350-S



Bisagra cristal a cristal 90°.

- Para: 8-12 mm.
- Soporta: 25 kg.
- Material: Acero inox. 304.
- Acabado: SH350-C Cromo. SH350-S Satín.

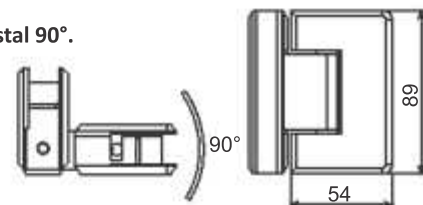

MODELOS SH330 / SH340 / SH350

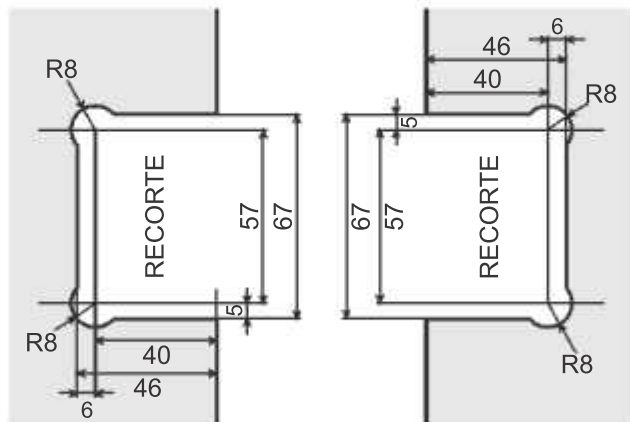

B-322



Bisagra hidráulica de piso entrada rectangular.

- Para: Puerta máx. 1 m.
- Soporta: 130 kg.
- Acabado: Satín.

PUNTO DE GIRO

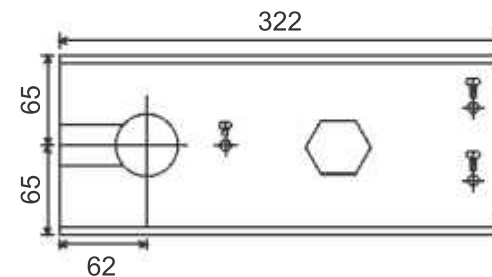
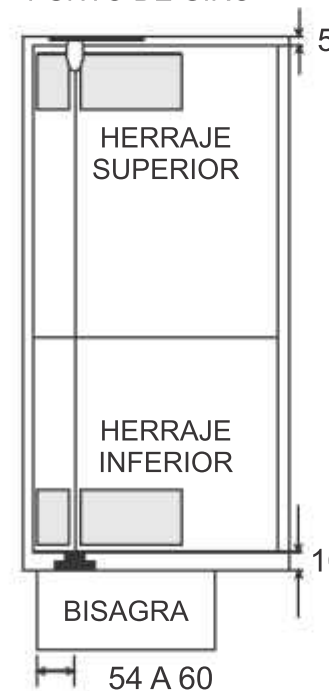

K-258-1

Separador redondo hueco.

Varias medidas.

- Soporta: 30 kg.
- Material: Acero inox.
- Acabado: Satín.

- k-258-1-19*20 19*20
- k-258-1-19*25 19*25
- k-258-1-19*30 19*30
- k-258-1-25*20 25*20
- k-258-1-25*25 25*25
- k-258-1-25*30 25*30
- k-258-1-25*40 25*40
- k-258-1-30*40 30*40
- k-258-1-30*50 30*50
- k-258-1-30*60 30*60
- k-258-1-30*70 30*70
- k-258-1-40*40 40*40
- k-258-1-40*50 40*50
- k-258-1-40*60 40*60
- k-258-1-40*70 40*70

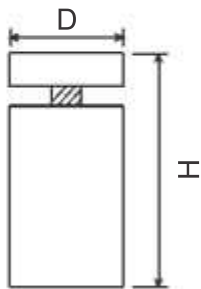

D \ H	20	25	30	40	50	60	70	80	100
12	20	25	30	40	50	60	70	80	100
16	20	25	30	40	50	60	70	80	100
19	20	25	30	40	50	60	70	80	100
25	20	25	30	40	50	60	70	80	100
30	20	25	30	40	50	60	70	80	100
40	20	25	30	40	50	60	70	80	100

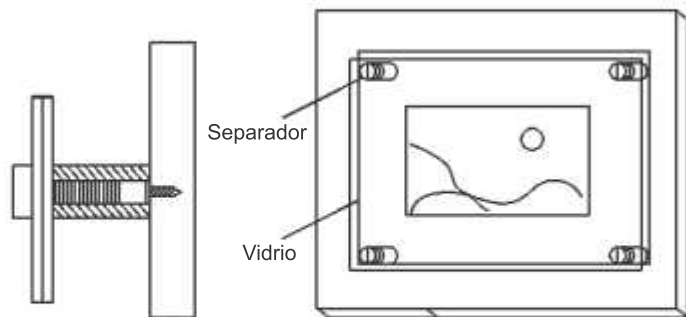

C-005



Soporte de fijación doble tapa.

- Para: 8-12 mm.
- Soporta: 30 kg.
- Material: Acero inox. 304.
- Acabado: Satín.

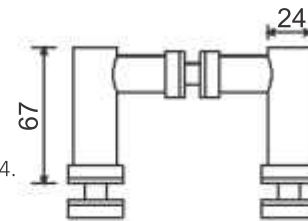

C-003



Soporte de fijación muro a cristal con taquete.

- Para: 8-12 mm.
- Soporta: 30 kg.
- Material: Acero inox. 304.
- Acabado: Satín.

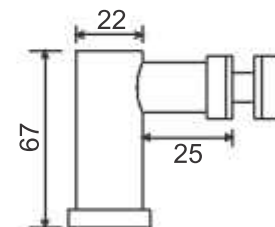

C-001



Soporte de fijación cristal a cristal.

- Para: 8-12 mm.
- Soporta: 30 kg.
- Material: Acero inox. 304.
- Acabado: Satín.

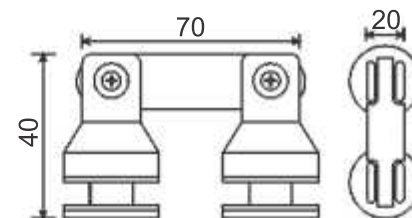

K-957-25



Soporte para tubo.

- Para: 1 pulgada.
- Soporta: 20 kg.
- Material: Acero inox.
- Acabado: Satín.
- Venta por par.

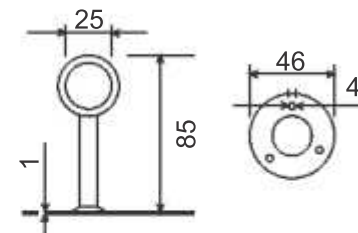

K-957-32



Soporte para tubo.

- Para: 1.5 pulgadas.
- Soporta: 20 kg.
- Material: Acero inox.
- Acabado: Satín.
- Venta por par.

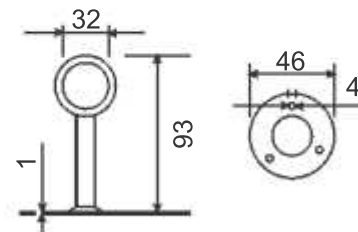

K-961-25

**Soporte para tubo.**

- Para: 1 pulgada.
- Soporta: 20 kg.
- Material: Acero inox.
- Acabado: Satín.
- Venta por par.

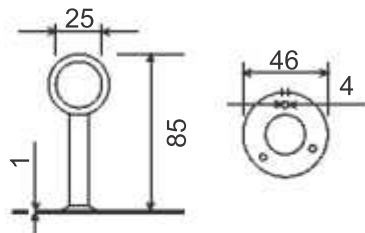

K-961-32

**Soporte para tubo.**

- Para: 1.5 pulgadas.
- Soporta: 20 kg.
- Material: Acero inox.
- Acabado: Satín.
- Venta por par.

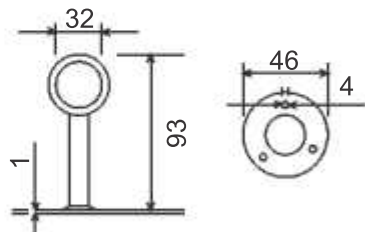

PH800-1-SN

**Conector muro a tubo.**

- Soporta: 30 kg.
- Material: Acero inox. 304.
- Acabado: Satín.

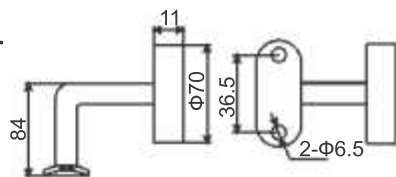

PH800-SN

**Conector vidrio a tubo.**

- Para: 8-12 mm.
- Soporta: 30 kg.
- Material: Acero inox. 304.
- Acabado: Satín.

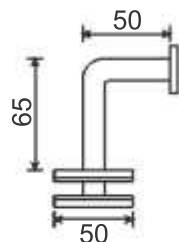

C011

**Conector vidrio a vidrio.**

- Material: Acero inox. 304.
- Acabado: Satín.

C012

**Conector muro a vidrio con taquete.**

- Material: Acero inox. 304.
- Acabado: Satín.

PH001-SN

**Brida con cuello para tubo.**

- Para: 1.5".
- Material: Acero inox. 304.
- Acabado: Satín.

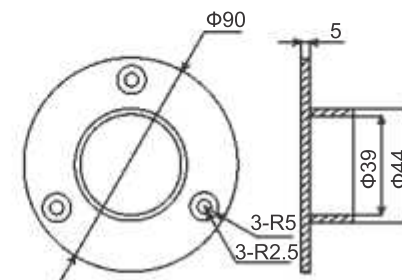

PH002-SN

**Brida con cuello para tubo.**

- Para: 2".
- Material: Acero inox. 304.
- Acabado: Satín.

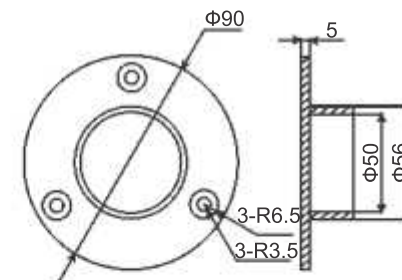

PH003-SN

**Poste para barandal con cuello y tapa.**

- Para: 1.5".
- Material: Acero inox. 304.
- Acabado: Satín.

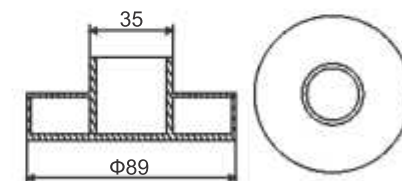

ZJ-020



Herraje superior.

- Para: 14 mm.
- Puerta máx. 1 m.
- Material: Acero inox. 304.
- Acabado: Satín.

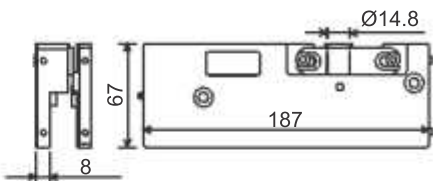

HP-L



Sistema hidráulico sin poso.

- Para: 8-12 mm.
- Puerta máx. 1 m.
- Soporta: 100 kg.
- Acabado: Satín
- No necesita bisagra hidráulica.

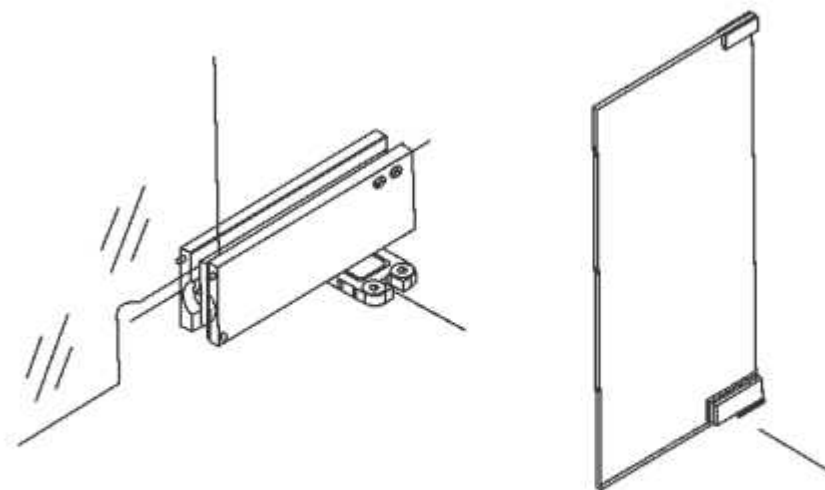
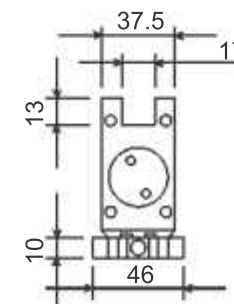
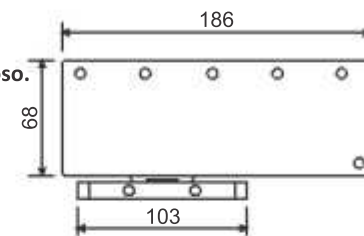

A-607



Punto de giro superior.

- Material: Acero inox. 304.
- Acabado: Satín.

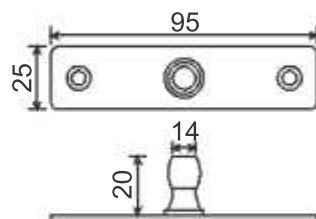

D-020



- Herraje superior.**
- Para: 8-12 mm.
 - Puerta máx. 1 m.
 - Material: Acero inox. 304.
 - Acabado: Satin.

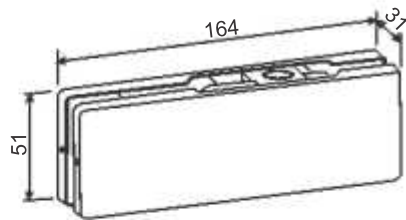

CORTE DE VIDRIO

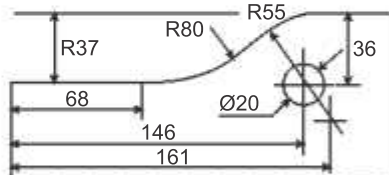

D-010



- Herraje inferior.**
- Para: 8-12 mm.
 - Puerta máx. 1 m.
 - Material: Acero inox. 304.
 - Acabado: Satin.

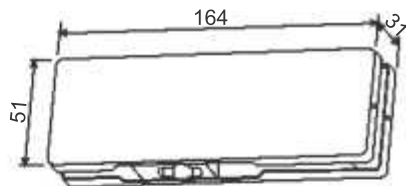

CORTE DE VIDRIO

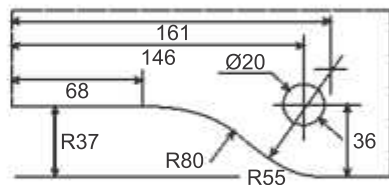

Cerradores, sistemas corredizos y cerraduras.

XH-073	1
XH-072	1
XH-071	1
XH-1501	2
XH-1601	2
KH01	3
KH01Z	3
KH01S	3
KH02	3
N0115	3
N0208	3
O15C	3
O15S	3
R6M	3
R3M	3
XH-82801	5
XH-82802	5
XH-82803	5
XH-82804	5
XH-82805	5
XH-82806	6
XH-83101	7
XH-83102P	7
XH-83301	7
XH-83302	7
XH-84201	7
XH-84202	8
XH-84801	8
XH-84802P	9
D-050	9

Jaladeras, clips, bisagras y separadores.

K-247-S	10
K-264-C	10
K-264-S	10
K-276-C	10
K-276-S	10
25*300-C	10
25*300-SN	11
19*150-C	11
19*150-SN	11
SH-250-50	11
SH-250-90	11
SH-250-120	11
SH-530	11
K-121-12-C	12
K-121-12-S	12
K-128-12-C	12
K-128-12-S	12
K-169-C	12
K-169-S	12
K-170-C	12
K-170-S	12
K-170-1-C	12
K-170-1-S	12
K-826	13
K-827	13
K-163	13
K-163-1	13
K-165	13
K-166	14
K-822	14
K-823	14
K-824	14
K-153-C	14
K-153-S	14
K-153-1-C	15
K-153-1-S	15
K-869-C	15

Jaladeras, clips, bisagras y separadores.

K-246-C	10
K-246-S	10
K-247-C	10

Jaladeras, clips, bisagras y separadores.

K-869-S	15
K-870-C	15
K-870-S	15
K-510-C	15
K-510	15
K-512-C	15
K-512	15
K-513	16
K-518-C	16
K-518	16
K-507-C	16
K-507	16
K-508-C	16
K-508	16
K-858-C	16
K-858-S	16
K-861-C	17
K-861-S	17
K-862-C	17
K-862-S	17
K-844	17
K-846	17
K-174-10	17
K-946	18
K-947	18
K-803	18
ZL6214-C	18
ZL6214-SN	18
ZL6215-C	18
ZL6215-SN	18
Z6216-C	19
Z6216-SN	19
Z6217-C	19
Z6217-SN	19
Z6218-C	19
Z6218-SN	19

Jaladeras, clips, bisagras y separadores.

SH310-C	20
SH310-S	20
SH320-C	20
SH320-S	20
SH330-C	21
SH330-S	21
SH340-C	21
SH340-S	21
SH350-C	21
SH350-S	21
B-322	22
K-258-1	23

Soportes y complementos.

C-005	24
C-003	24
C-001	24
K-957-25	24
K-957-32	24
K-961-25	25
K-961-32	25
PH800-1-SN	25
PH800-SN	25
C011	25
C012	26
PH001-SN	26
PH002-SN	26
PH003-SN	26
ZJ-020	27
A-607	27
HP-L	28
D-020	29
D-010	29

